

Thank you for purchasing this quality product. Be sure to check all packing material carefully for small parts that may have come loose inside the carton during shipment.

Parts key

No	Code	Qty	Description	No	Code	Qty	Description
1	1706-70P05	6 Pcs.	Drawer Complete	7	1706-70P08P	4 Pcs.	Shelf Pin
2	1706-70P06	6 Sets.	Drawer Glide	8	1706-70P02M	2 Pcs.	Center Leg
3	1706-70P07R	1 Pc.	Right Facing Door	9	1706P01F	4 Pcs.	Floor Glide
4	1706-70P07L	1 Pc.	Left Facing Door	10	1706P01L	2 Pc.	Leveler
5	1706-70P04	2 Pcs.	Wood Handle W/Screws	11	1706P01AT	1 Set.	Anti- Tip Kit
6	1706-70P08	1 Pc.	Shelf				

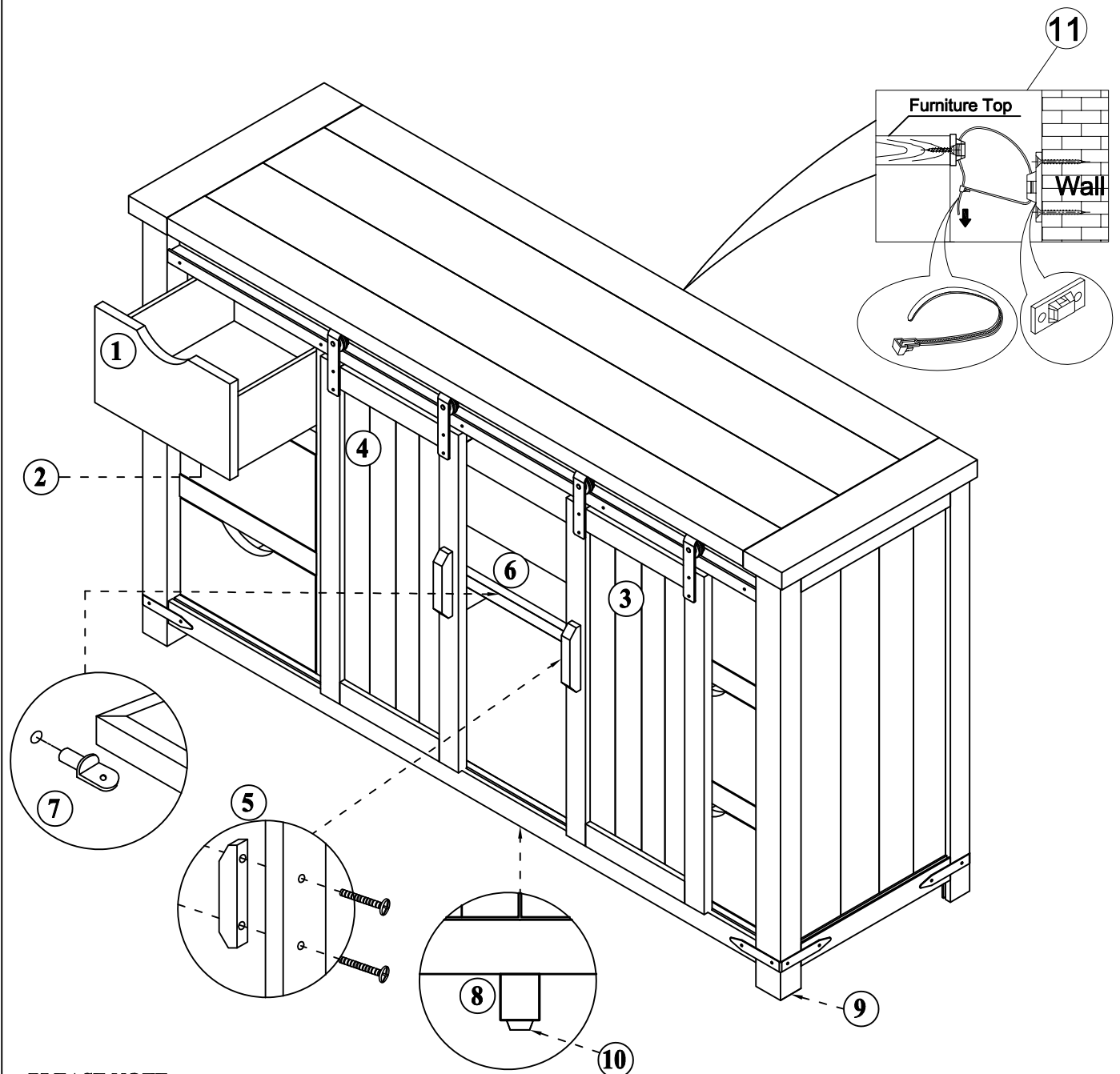

PLEASE NOTE :
To avoid the possibility of the furniture tipping and injury. The anti tip hardware must be installed