





Thank you for purchasing this quality product. Be sure to check all packing material carefully for small parts that may have come loose inside the carton during shipment.

Key Parts			
No	Code	Description	Q'Ty
1	649-3P24	Table Top	1 pc
2	649-3P02	Side Leg Assembly	2 pcs
3	649-3P08	Shelf	1 pc
4	649-3P01F	Floor Glide	4 pcs

Hardware kit (649-3P01)			
No		Description	Q'Ty
A		Long Bolt Ø8 x 50mm	8 pcs
B		Lock Washer Ø8	10 pcs
C		Flat Washer Ø8	10 pcs
D		Allen Key	1 pc
E		Short Bolt Ø8 x 35mm	2 pcs

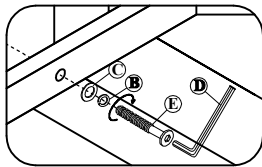

**DETAIL B**

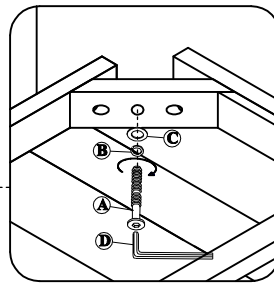

**DETAIL A**

**STEP 1**

-Attach Legs Frame to Table Top  
-Insert a Bolt (A) with Flat washer (C), Lock washer (B) through holes in wood corner of Table Top. Do not fully tighten.

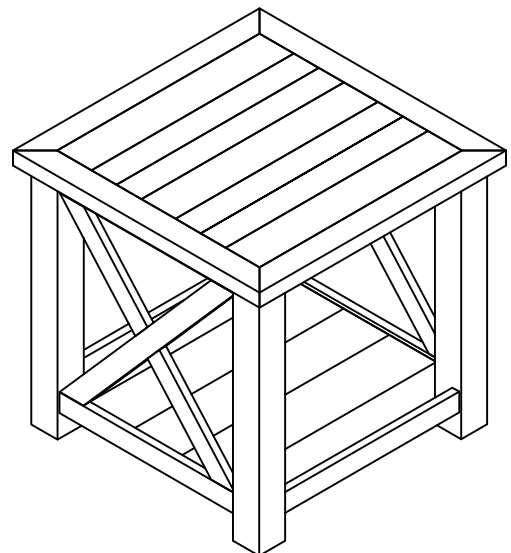
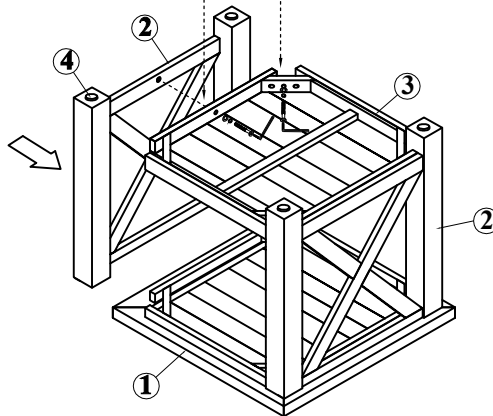

**STEP 2**

-Insert the Shelf into designed locations as shown in illustration.  
-Insert a Flat washer (C), Lock washer (B) with a Long Bolt (A) into each of the 4 holes in the corner of the Shelf to attach the shelf to the leg and Short Bolt (E), Lock Washer (B) and Flat Washer (C) into each of the two holes in the center of the Shelf Side. (See Detail A & B).  
-Fully tighten all bolts with Allen key (D).  
-Carefully turn Side Table upright.