

Thank you for purchasing this quality product. Be sure to check all packing material carefully for small parts that may have come loose inside the carton during shipment.

KEY COMPONENTS

NO.	CODE	Q'TY	DESCRIPTION	NO.	CODE	Q'TY	DESCRIPTION
1	2338FP-P07L	1 PC	LEFT SIDE FACING DOOR	6	2338FP-P07H	4 PCS	DOOR HINGE
2	2338FP-P07R	1 PC	RIGHT SIDE FACING DOOR	7	2338FP-P01D	2 PCS	DOOR CATCH
3	2338FP-P04	2 PCS	DOOR PULL W/ SCREW	8	2338P01AT	1 KIT	ANIT-TIP KIT
4	2338FP-P08	2 PCS	SHELF	9	2338FP-P01L	6 PCS	LEVELERS
5	2338FP-P08P	8 PCS	SHELF PIN	10	2338FP-P01B	1 PC	SUPPORT BLOCK

Step 1:

Carefully slide the Firebox insert carton out of the console from the back. Remove the Firebox insert from the carton and place on a clean, protected surface.

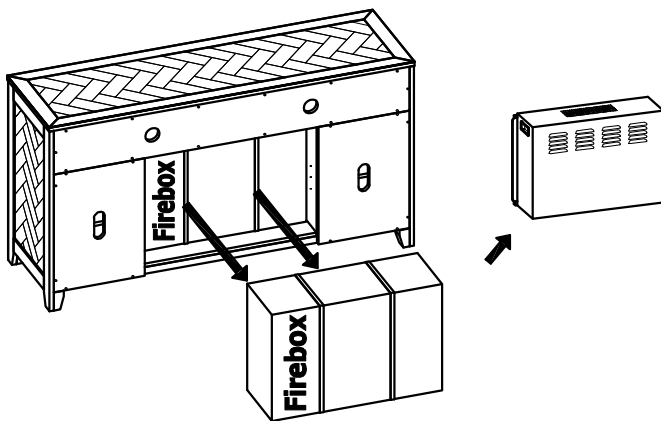

Step 2:

Insert the Firebox into the back of the cabinet. Attach the support bracket to secure the Firebox from behind the cabinet. Refer to the separate booklet for the fireplace insert for complete instructions.

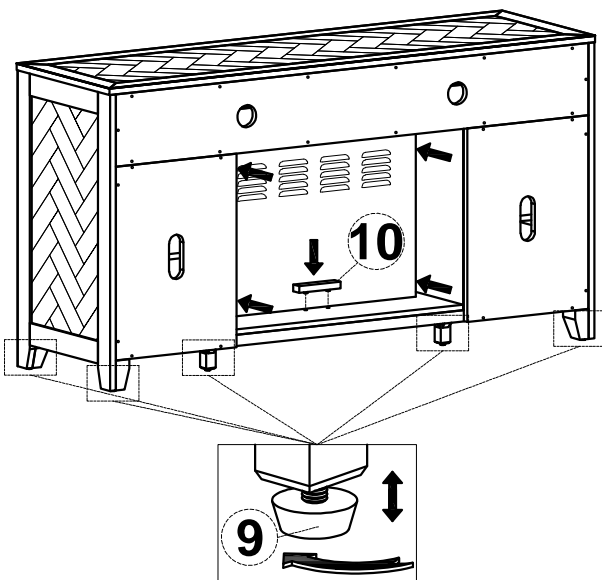

Step 3:

Remove the door pulls from the back side of the door and attach them to the front side of the door with a Phillips headscrewdriver, as shown in the diagram.

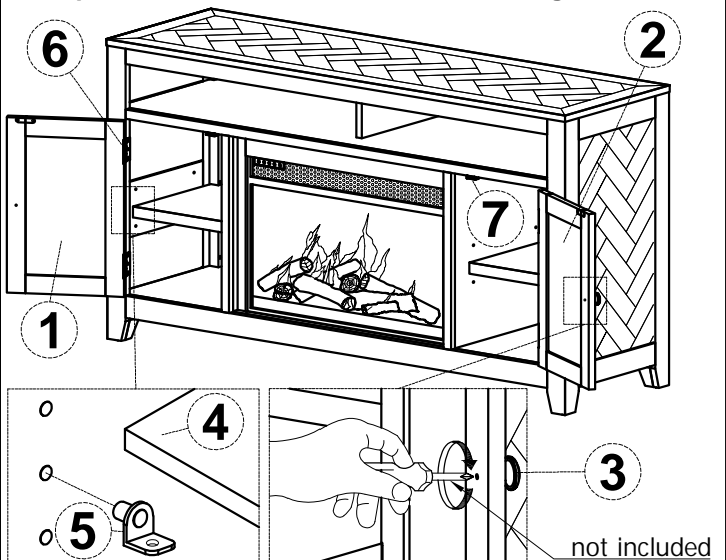

Step 4:

Install the Anti-Tip Hardware to avoid the possibility of the furniture tipping and injury.

