







ASSEMBLY INSTRUCTIONS & PARTS IDENTIFICATION MODEL # 2301-RCT72 RECLAMATION RECT DINING TABLE

Thank you for purchasing this quality product. Be sure to check all packing material carefully for small parts that may have come loose inside the carton during shipment.

Parts			
No.	Code	QTY	Description
1		1 PC	Table Top
2	2301-RCT72P02	4 PCS	Leg
3	2301P01F	4 PCS	Floor Glides

Hardware Kit (2301-RCT72P01)			
No.		Description	Qty
A		Flat washer M10x18	20 pcs
B		Lock Washer M10	12 pcs
C		Bolt M8x30	4 pcs
D		Bolt M10 x 90	8 pcs
E		Wrench	1 pc
F		Nut	8 pcs

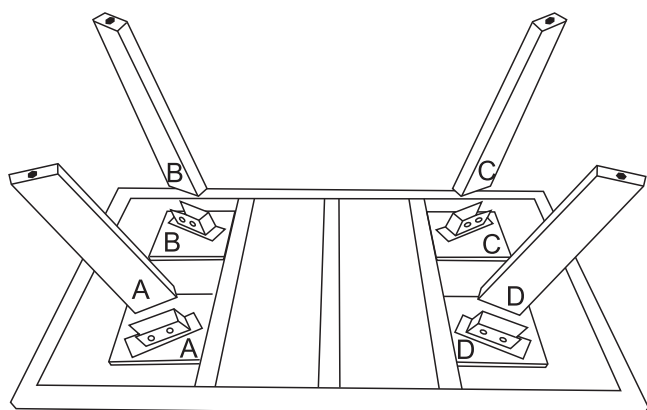

- CAREFULLY LAY TABLE UPSIDE DOWN ON SMOOTH SURFACE TO PREVENT SCRATCHING.
- POSITION THE LEG IN THE BRACKET WITH A BOLT "D" AND A FLAT WASHER. PUT ALL THE BOLTS THROUGH THE LEGS IN EACH POSITION.
- ATTACH THE BOLT USING A FLAT WASHER, LOCK WASHER, AND A NUT. DO NOT FULLY TIGHTEN AT THIS POINT.
- ATTACH BOLT "C" WITH A LOCK WASHER AND A FLAT WASHER TO THE FRONT POSITION OF THE LEG AND TIGHTEN WITH THE WRENCH PROVIDED.
- TIGHTEN ALL NUTS FIRMLY.
- TWO PERSON REQUIRED TO FLIP THE TABLE

