







ASSEMBLY INSTRUCTIONS & PARTS IDENTIFICATION MODEL # 2271-BURKEBNG BURKE BENCH - GOLDEN

Thank you for purchasing this quality product. Be sure to check all packing material carefully for small parts that may have come loose inside the carton during shipment

KeyParts			
No	Code	Qty	Description
1	2271-BURKEBNGP41	1pc	Bench Top
2	2271-BURKEBNGP42	2pcs	Leg Assembly
3	2271-BURKEBNGP11	1pcs	Support Stretcher
4	2271-BURKEP01F	4pcs	Floor Glide

Hardware kit (2271-BURKEBNGP46)			
No	Description	Qty	
A	 Flat washer (Large) For Bracket	8 pcs	
B	 Flat washer (Small) For Stretcher	2 pcs	
C	 Lockwasher	10 pcs	
D	 Bolt 8x25mm - To attach the Bracket	8 pcs	
E	 Bolt 8x75mm - To attach Support Stretcher	2 pcs	
F	 Allen Key	1 pcs	
G	 Metal Corner Bracket	4 pcs	

Step 1

Attach the Support Stretcher to the bench top using a Long Bolt E, Lock Washer C, and Small Flat Washer B. Fully tighten bolts after both bolts are in place.

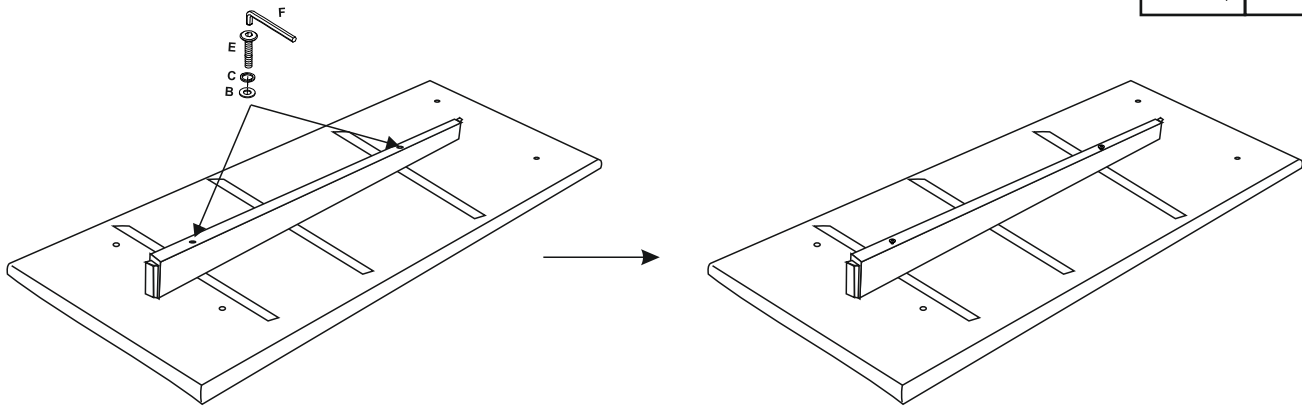

SETUP REQUIRES 2 PEOPLE



Step 2

Attach two Metal Corner Brackets G to the inside of each panel of the Leg Assembly using a Short Bolt D, Lock Washer C, and Large Flat washer A. Do not fully tighten at this point.

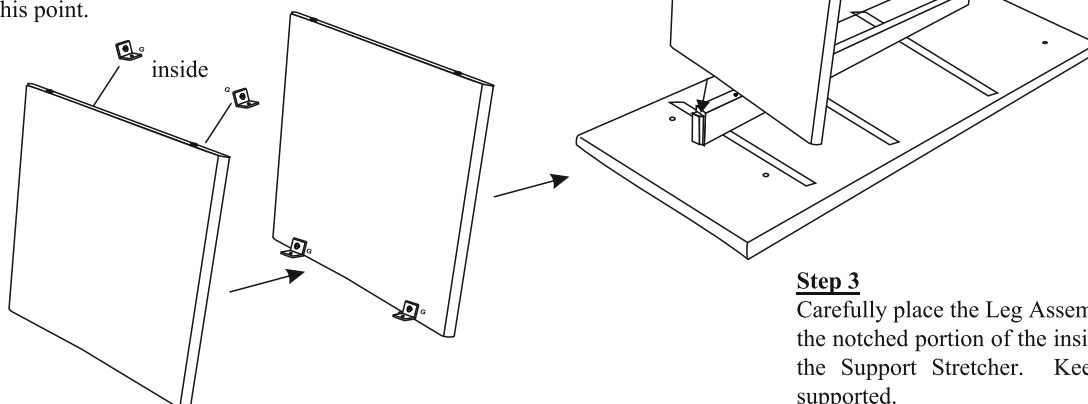







Step 3

Carefully place the Leg Assembly into place by inserting the notched portion of the inside panel to the receiver on the Support Stretcher. Keep Leg Assembly Panels supported.

ASSEMBLY INSTRUCTIONS & PARTS IDENTIFICATION MODEL # 2271-BURKEBNG BURKE BENCH - GOLDEN

Thank you for purchasing this quality product. Be sure to check all packing material carefully for small parts that may have come loose inside the carton during shipment

KeyParts			
No	Code	Qty	Description
1	2271-BURKEBNGP41	1pc	Bench Top
2	2271-BURKEBNGP42	2pcs	Leg Assembly
3	2271-BURKEBNGP11	1pcs	Support Stretcher
4	2271-BURKEP01F	4pcs	Floor Glide

Hardware kit (2271-BURKEBNGP46)			
No		Description	Qty
A		Flat washer (Large) For Bracket	8 pcs
B		Flat washer (Small) For Stretcher	2 pcs
C		Lockwasher	10 pcs
D		Bolt 8x25mm - To attach the Bracket	8 pcs
E		Bolt 8x75mm - To attach Support Stretcher	2 pcs
F		Allen Key	1 pcs
G		Metal Corner Bracket	4 pcs

Step 4

Attach the Metal Corner Bracket to the bench top using a Short Bolt D, Lock Washer C, and Large Flat washer A, leaving the bolts loose at this time. Once all bolts are on place, fully tighten by hand using the provided Allen Key.

SETUP REQUIRES
2 PEOPLE

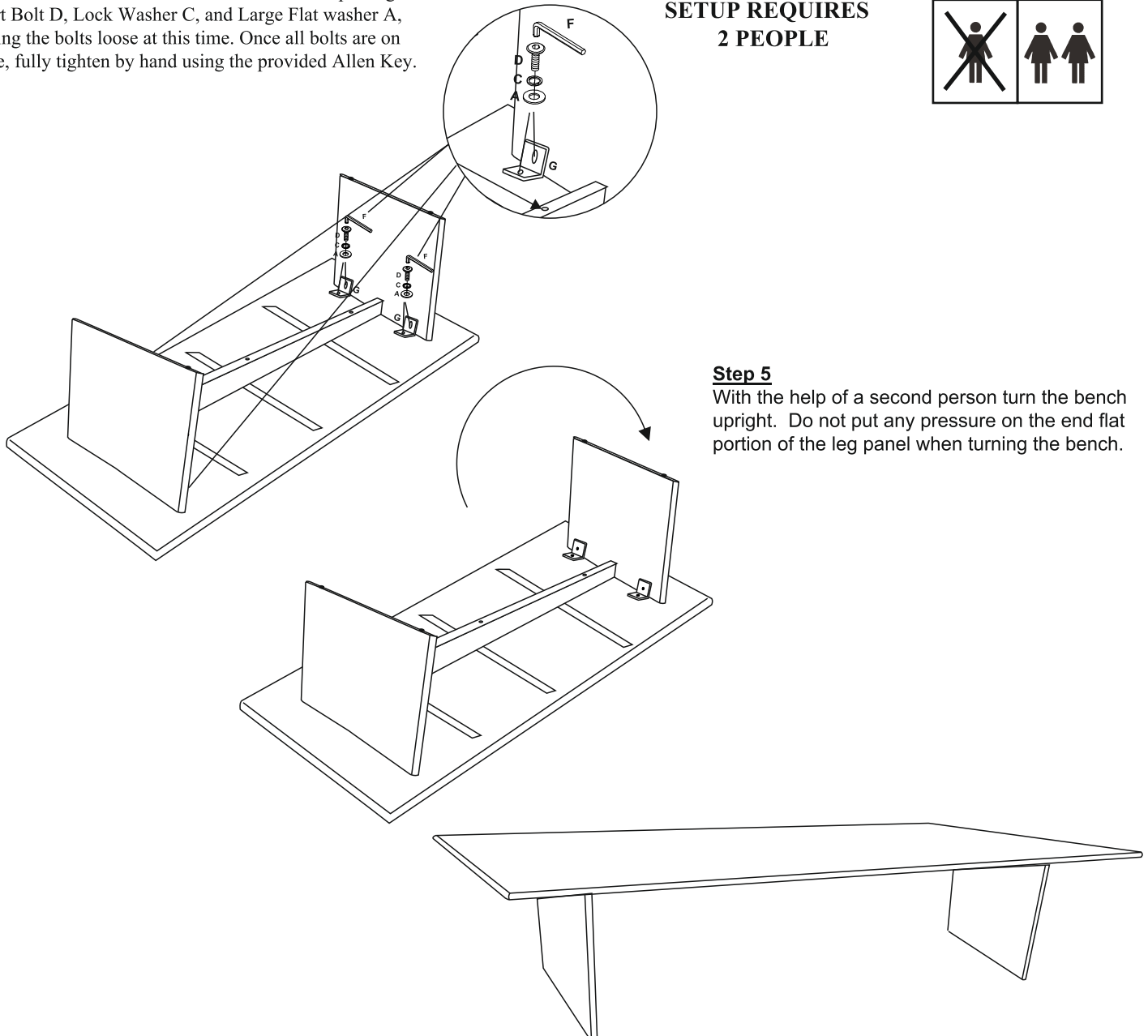

Step 5

With the help of a second person turn the bench upright. Do not put any pressure on the end flat portion of the leg panel when turning the bench.