

Thank you for purchasing this quality product. Be sure to check all packing material carefully for small parts that may have come loose inside the carton during shipment.

Parts key							
No	Code	Qty	Description	No	Code	Qty	Description
1	2156-79P07L	2 pcs	Left Side Facing Door	6	2156-79P08	2 pcs	Shelf
2	2156-79P07R	2 pcs	Right Side Facing Door	7	2156P08P	8 pcs	Shelf Pin
3	2156P07H	8 pcs	Door Hinge	8	2156P01F	4 pcs	Floor Glide
4	2156P04	4 sets	Door Pull w/Screws	9	2156P01L	1 pc	Floor leveler
5	2156P01D	4 sets	Door Catch	10	2156P01AT	1 set	Anti-Tip Kit

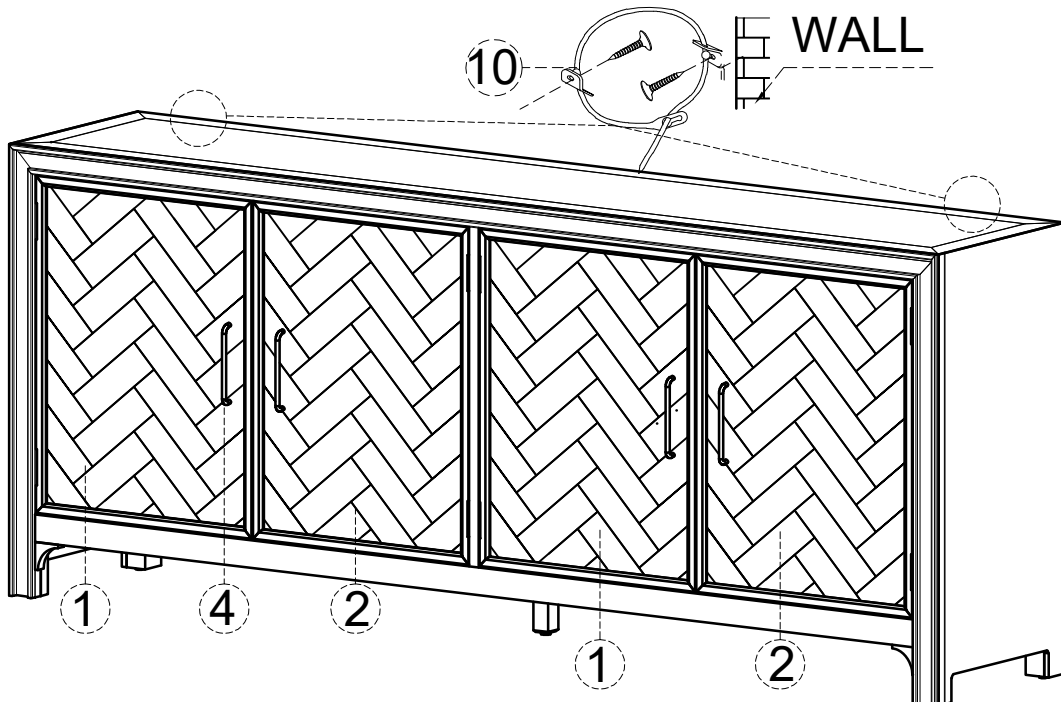
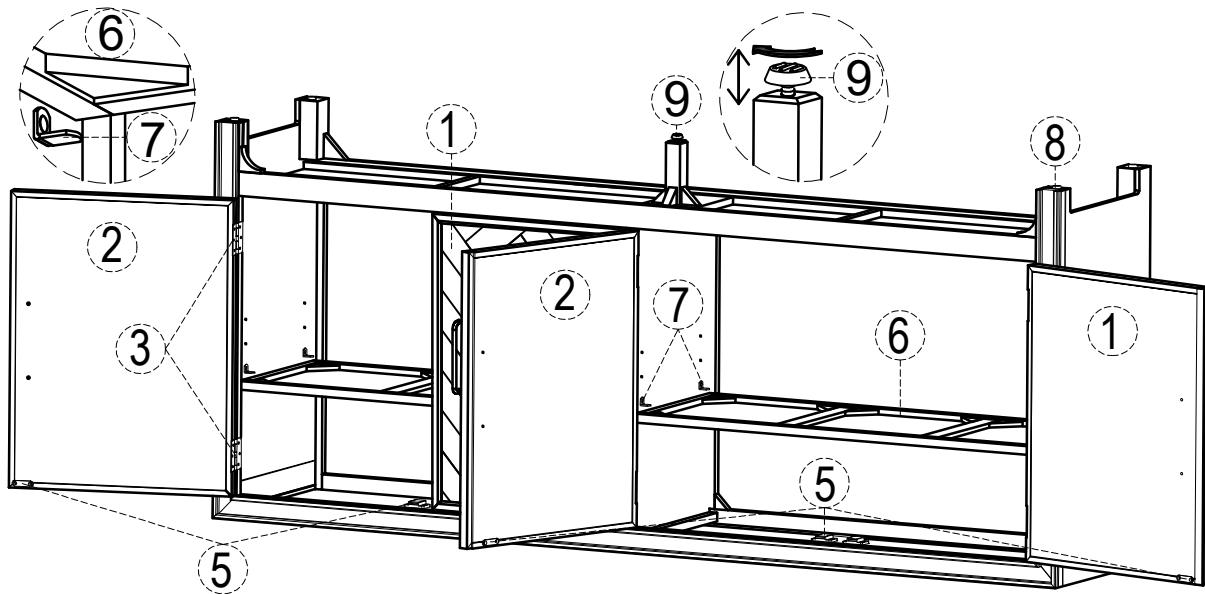

PLEASE NOTE :
To help prevent the possibility of tip-over. Install the ANTI-TIP over restraint provided.