

Thank you for purchasing this quality product. Be sure to check all packing material carefully for small parts that may have come loose inside the carton during shipment

Hardware kit 2130-370KDP46			
No		Description	Q'ty
A		Hexa Nut 5/16"	4 pcs.
B		Lock Washer 5/16"	11 pcs.
C		Flat Washer 5/16"	11 pcs.
D		Long Bolt 1/4"x 3".	4 pcs.
E		Short Bolt 1/4"x 1 1/2.	3 pcs.
F		Allen Key	1 pc.
G		Key Wrench	1 pc.
H		Wood Screw 1/6"x 38	4 pcs.

Chair Parts Key			
No	Code	Description	Q'ty
1	2130-370KDP40	Chair Back	1 pc.
2	2130-370KDP41	Complete Seat	1 pc.
3	2130-370KDP42	Right Facing Front Leg	1 pc.
4	2130-370KDP43	Left Facing Front Leg	1 pc.
5	2130-370KDP44	Right Facing Stretcher	1 pc.
6	2130-370KDP45	Left Facing Stretcher	1 pc.
7	2130-370P01F	Floor glide	4pcs.

**FABRIC CARE INTRUCTIONS:** Blot gently using a clean soft damp cloth an mild detergent **DO NOT SATURATE FABRIC CONTENT:** 100% POLYESTER-CLEANING CODE W

### STEP 1

- Carefully lay chair back flat on a smooth flat surface to prevent scratches
- Attach Complete Seat to Chair back by inserting a Flat Washer (C) Lock Washer (B) with Short Bolt (E) into each of the hole on the back rail of the seat, and Long Bolt (D) a Flat Washer (C) and Lock Washer (B) into each of 2 holes in the Complete Seat corners. (See Detail A & B)
- Tighten screws with provided Allen Key (F) by turning clockwise until secure

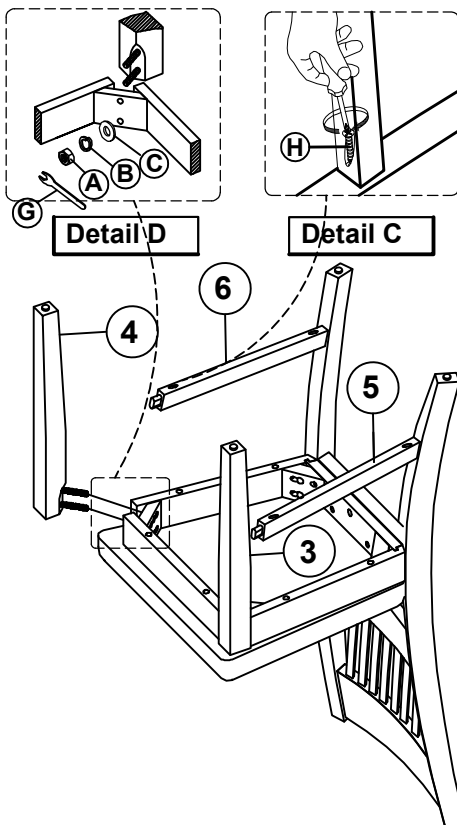

### STEP 2

- Carefully turn Chair upside down. Insert the right stretcher into the back right leg, then position right front leg in to the front corner block and connect the stretcher to the front leg
- Insert the left stretcher into the back left leg, then position left front leg in to the front corner block and connect the stretcher to the front leg. (See Detail C)
- Place Flat Washer (C), Lock Washer (B) and Nut (A) on each bolt, and hand tighten at this point
- Fasten Stretchers with Wood Screws (H) by hand using a Philips screwdriver (not provider) ( See Detail C). Fully tighten the nuts for the front leg.
- Check to be sure all screws and nuts are tight prior to using Chair.

