





Thank you for purchasing this quality product. Be sure to check all packing material carefully for small parts that may have come loose inside the carton during shipment.

Key Parts			
No	Code	Qty	Description
1	1985-BS160KDP42B	1pc	Leg assembly
2	1985-BS160KDP41	1pc	Seat
3	1985-BS160KDP01F	4pc	Floor glide

Hardware kit(1985-BS160KDP46)		
No	Description	Qty
A	 Flat washer	4 pcs
B	 Lock washer	4 pcs
C	 Allen key bolt 8x30 mm	4 pcs
D	 Allen key	1 pc



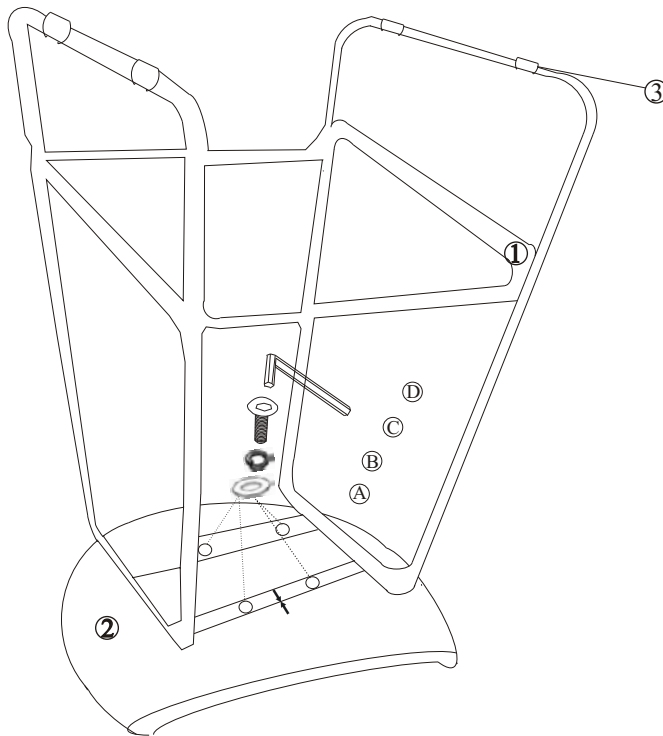

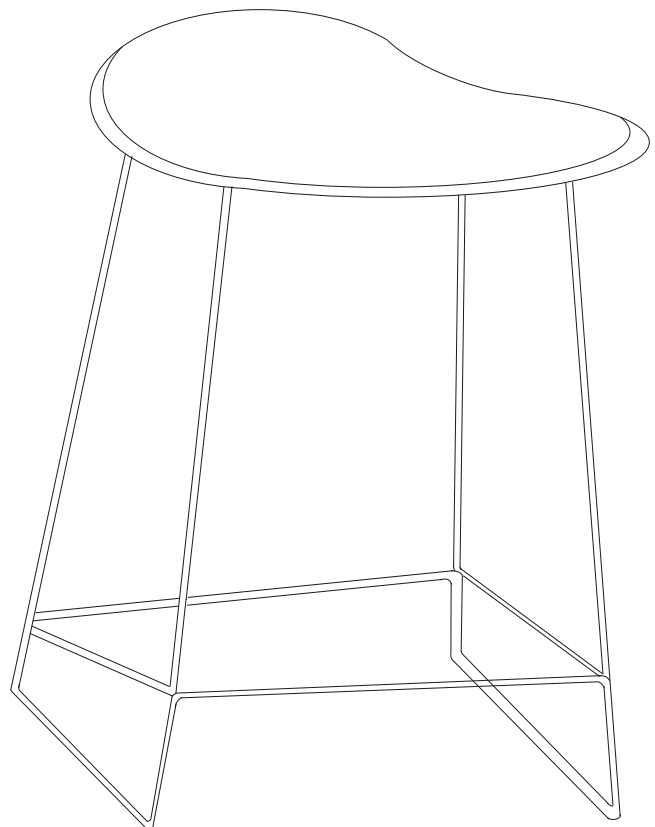

Place the leg assembly on the seat, aligning the arrows. Insert a bolt, lock washer and flat washer into each of the four holes and hand tighten with the Allen wrench



ASSEMBLY INSTRUCTIONS & PARTS IDENTIFICATION MODEL # 2085-52 COUNTER HEIGHT TABLE

Thank you for purchasing this quality product. Be sure to check all packing material carefully for small parts that may have come loose inside the carton during shipment.

Key Parts			
No.	Code	Qty.	Description
1	2085-52P02	4 Pcs	Legs
2	2085-52P05	3 Pcs	Complete drawers
3	2085-52P05A	3 Pcs	Drawer stopper
4	2085P01L	4 Pcs	Floor levelers

Hardware Kit (2085P01)			
No.	Description		Qty.
A		Flat Washer	8 Pcs
B		Lock Washer	8 Pcs
C		Bolt 8x25 mm	8 Pcs
D		Key Wrench	1 Pc

