







Thank you for purchasing this quality product. Be sure to check all packing material carefully for small parts that may have come loose inside the carton during shipment.

Parts key				Hardware kit # 2005-42P01			
No	Code	Qty	Description	No	Description		Qty
1	2005-42P24	1 pc	Top Frame	A	 Bolt	Ø6 x 20	12 pcs
2	2005-42P09	1 pc	Round Glass Insert	B	 Lock washer	Ø8	12 pcs
3	2005-42P02	4 pcs	Legs	C	 Flat washer	Ø8 x 18	12 pcs
4	2005-42P01F	4 pcs	Floor Glide	D	 Allen key	K4	01 pc
				E	 Iron Plate		04 pcs
				F	 Wood Screw	Ø4 x 35	16 pcs

Do not use power tools to assemble this table

Step 1 Attach the Iron Plate "E" to the top of the legs, by using wood screws "F".

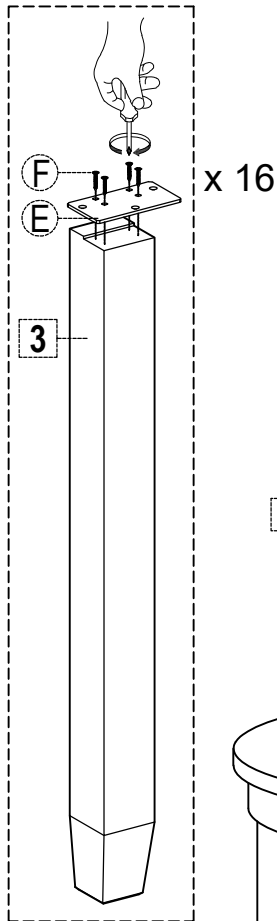

Step 2 Attach the legs to the position of the legs inside the top frame and attach as shown.

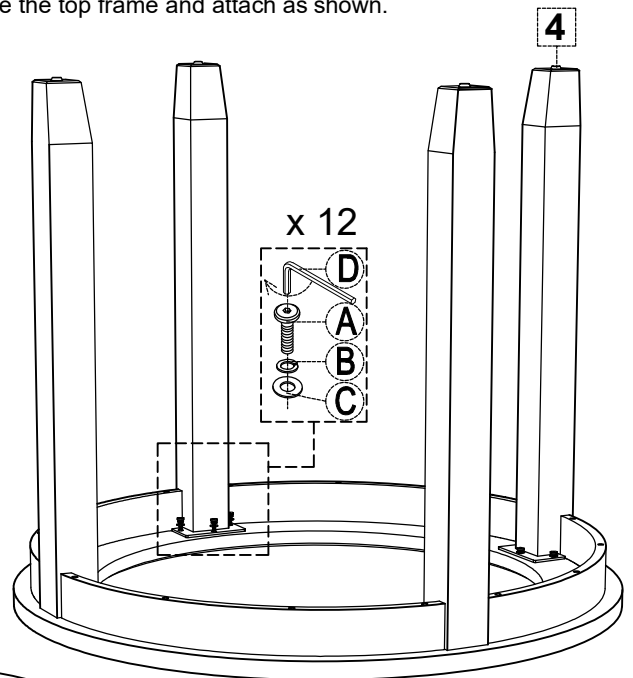

Finish

Carefully lay the Glass Insert in place

