









Thank you for purchasing this quality product. Be sure to check all packing material carefully for small parts that may have come loose inside the carton during shipment.

Parts key				Hardware kit # 2004-BS410KDP46				
No	Code	Qty	Description	No	Description			Qty
1	2004-BS410KDP40	1 pc	Chair Back	A		Hex nut	M8	4 pcs
2	2004-BS410KDP41	1 pc	Complete Seat	B		Lock washer	M8	11 pcs
3	2004-BS410KDP42	1 pc	Right Facing Front Leg	C		Flat washer	M8 x 18	11 pcs
4	2004-BS410KDP43	1 pc	Left Facing Front Leg	D		Long Bolt	M6 x 80	4 pcs
5	2004-BS410KDP44	1 pc	Right facing side stretcher	E		Short Bolt	M6 x 40	3 pcs
6	2004-BS410KDP45	1 pc	Left facing side stretcher	F		Allen Key	K4	1 pc
7	2004-BS410KDP49	1 pc	Front Stretcher	G		Key Wrench	13	1 pc
8	2004-BS410KDP01F	4 pcs	Floor Glide	H		Screw	M4 x 40	6 pcs

**FABRIC CARE INSTRUCTIONS  
REGULAR CARE**

Blot gently using a clean soft damp cloth and mild detergent DO NOT SATURATE  
FABRIC CONTENT: 100% Polyester - Cleaning code W

**Finish**

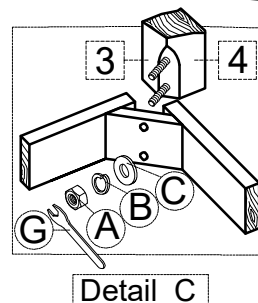
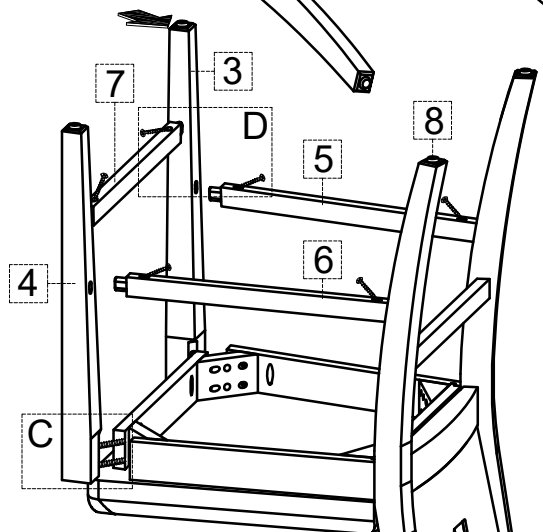
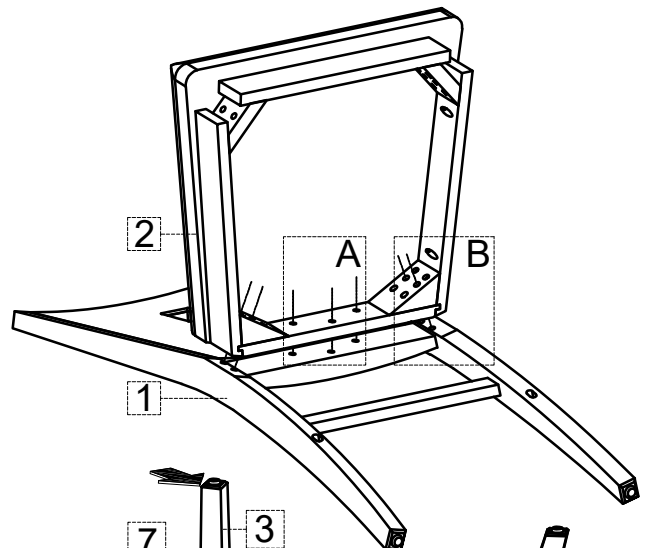
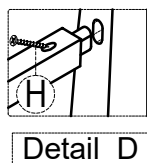
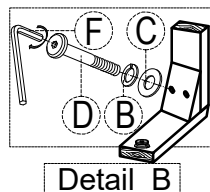
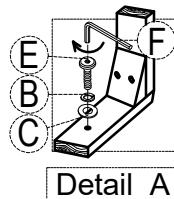
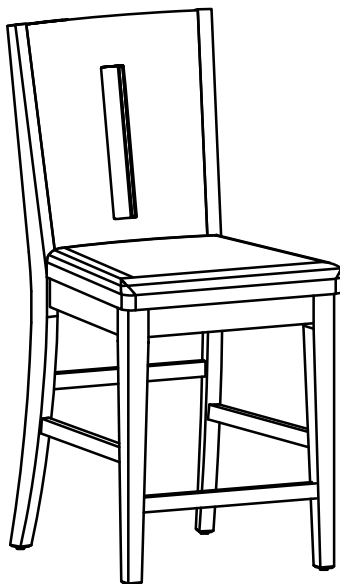

**Step 1**

- Carefully lay Chair Back flat on a smooth flat surface to prevent scratches.
- Attach Complete Seat (2) to Chair Back (1) by inserting a Flat Washer, Lock Washer and Short Bolt (E) into each of the hole on the back of the seat. Tighten screws with provided Allen Key by turning clockwise until secure. (See Detail A).
- Insert a Flat Washer, Lock Washer and Long Bolt (D) into each of 2 holes in the Complete Seat corners. Tighten screws with provided Key Wrench. (See Detail B).

**Step 2**

- Carefully turn chair upside down and attach each Front Leg to the front corners of the Complete Seat (Keeping in mind of the right side and left side leg) with a Flat Washer (C), Lock Washer (B) and Nut (A). (See detail C). Keep nut loose at this point.
- Insert right side stretcher and left side stretcher between the Front and Back Legs, then insert the Front Stretcher between the two Front Legs. (Make sure that the side stretchers are not at an angle as the front legs are on the wrong side). Fasten stretchers to legs with Screws (H) using a Screwdriver (not provide).
- Be sure to level the chair prior to tightening front leg nuts with wrench provided (G).