







Thank you for purchasing this quality product. Be sure to check all packing material carefully for small parts that may have come loose inside the carton during shipment.

Parts key				Hardware kit # 2003-66P01			
No	Code	Qty	Description	No	Description		Qty
1	2003-66P24	1 pc	Table Top	A	 Hex nut	M8	08 pcs
2	2003-66P09	2 pcs	Glass Insert	B	 Bolt	M6 x 30	16 pcs
3	2003-66P02	4 pcs	Legs	C	 Lock washer	M8	24 pcs
4	2003-66P13	2 sets	Extension Mechanism	D	 Flat washer	M8 x 18	24 pcs
5	2003-66P09S	8 pcs	Shield	E	 Allen key	K4	01 pc
6	2003-66P13L	4 sets	Extension Lock	F	 Key wrench	12	01 pc
7	2003-66P01F	4 pcs	Floor Glide				

Step 1

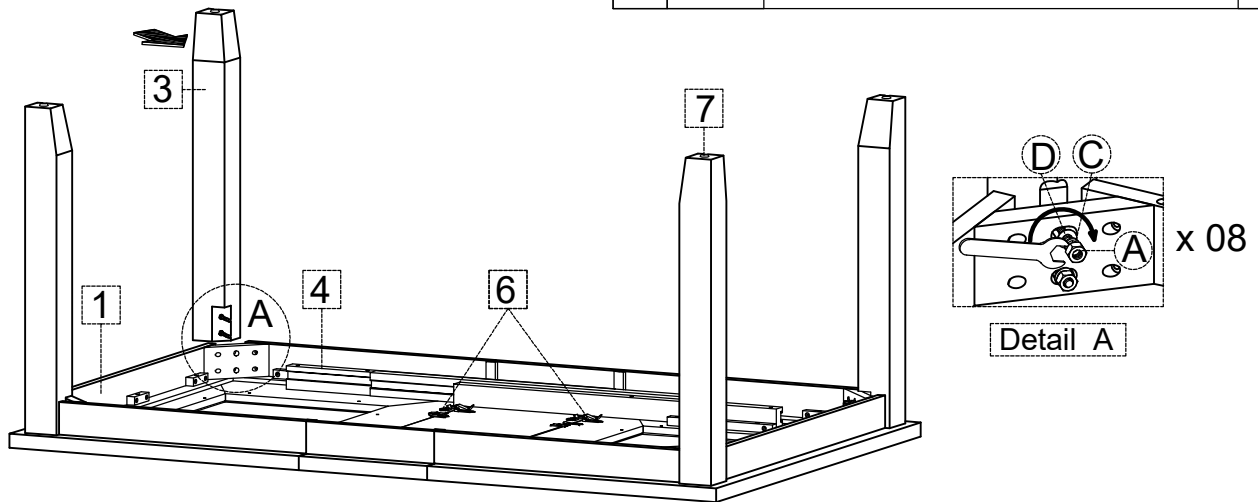

Step 2

