







Thank you for purchasing this quality product. Be sure to check all packing material carefully for small parts that may have come loose inside the carton during shipment.

Parts key				Hardware kit # 2002-1P01			
No	Code	Qty	Description	No	Description		Qty
1	2002-1P02	4 pcs	Legs	A	 Bolt - Large to attach the shelf	Ø6 x 50	04 pcs
2	2002-1P54	1 pc	Top Frame	B	 Bolt - Small to attach the legs	Ø6 x 15	08 pcs
3	2002-1P09	1 pc	Glass Insert	C	 Lock washer	Ø8	12 pcs
4	2002-1P08	1 pc	Shelf	D	 Flat washer	Ø8 x 18	12 pcs
5	2002-1P03	4 pcs	Casters with Screws	E	 Allen key	K4	01 pc
				F	 L Iron Plate		04 pcs
				G	 Wood Screw	Ø4 x 25	08 pcs

Do not use power tools to assemble this table

Step 1

Attach the L Plate "F" to the top of the legs, by using wood screws "G".

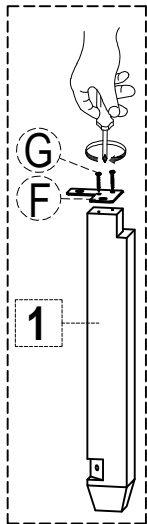

x 8

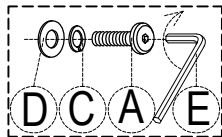

x 4

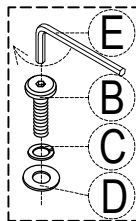

x 8

Step 2

Attach the legs to the shelf, then position the legs inside the top frame and attach as shown.

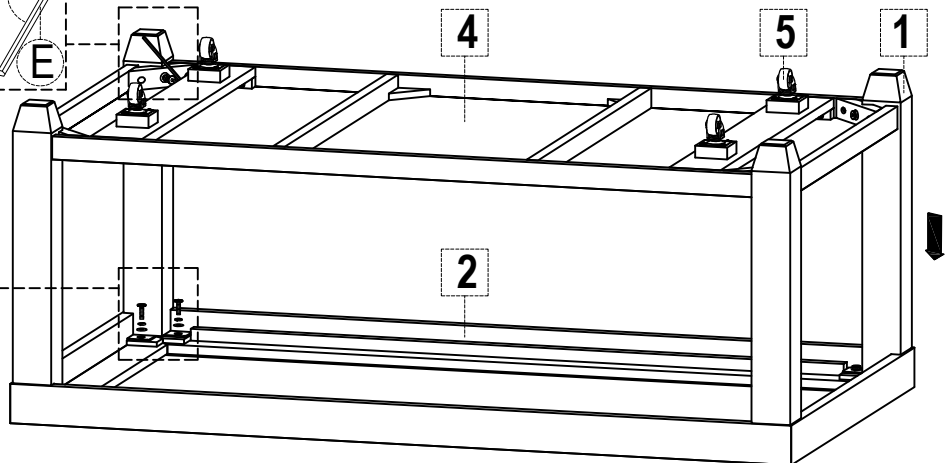

FINISH

Carefully lay the Glass Insert in place

