







Thank you for purchasing this quality product. Be sure to check all packing material carefully for small parts that may have come loose inside the carton during shipment.

Parts key				Hardware kit # 2001-7P01			
No	Code	Qty	Description	No	Description		Qty
1	2001-7P02	4 pcs	Legs	A	 Bolt - Large to attach the shelf	Ø6 x 50	08 pcs
2	2001-7P54	1 pc	Top Frame	B	 Bolt - Small to attach the legs	Ø6 x 15	08 pcs
3	2001-7P09	1 pc	Glass Insert	C	 Lock washer	Ø8	16 pcs
4	2001-7P08	2 pcs	Shelf	D	 Flat washer	Ø8 x 18	16 pcs
5	2001P01F	4 pcs	Floor Glide	E	 Allen key	K4	01 pc
				F	 L Plate		04 pcs
				G	 Wood Screw	Ø4 x 25	08 pcs

**Do not use power tools to assemble this table**

**Step 1**

Attach the L Plate "F" to the top of the legs, by using wood screws "G".

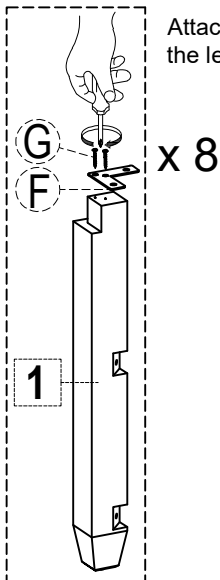

**Step 2**

Attach the legs to the shelves, then position the legs inside the top frame and attach as shown.

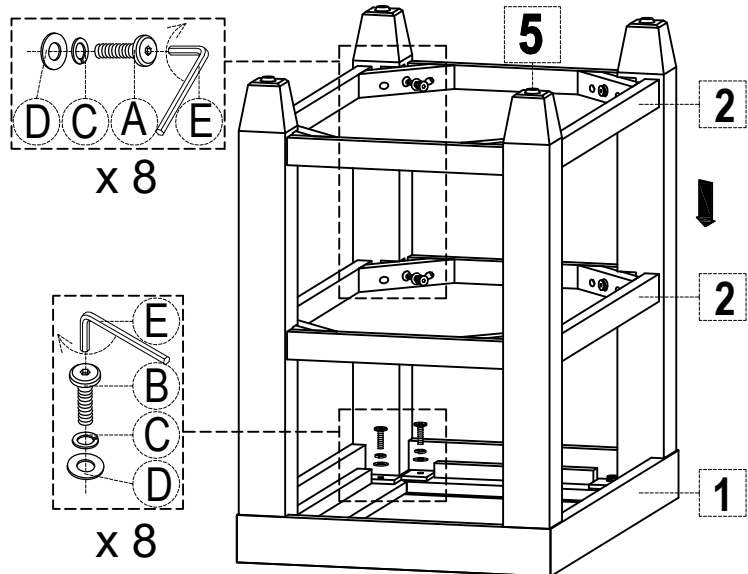

**FINISH**

Carefully lay the Glass Insert in place

