







Thank you for purchasing this quality product. Be sure to check all packing material carefully for small parts that may have come loose inside the carton during shipment.

Parts key				Hardware kit # 2000-2P01			
No	Code	Qty	Description	No		Description	Qty
1	2000-2P02	4 pcs	Legs	A		Bolt - Large to attach the shelf Ø6 x 50	04 pcs
2	2000-2P54	1 pc	Top Frame	B		Bolt - Small to attach the legs Ø6 x 15	08 pcs
3	2000-2P09	1 pc	Glass Insert	C		Lock washer Ø8	12 pcs
4	2000-2P08	1 pc	Shelf	D		Flat washer Ø8 x 18	12 pcs
5	2000-2P03	4 pcs	Casters with Screws	E		Allen key K4	01 pc
				F		I Iron Plate	04 pcs
				G		Wood Screw Ø4 x 25	08 pcs

### Do not use power tools to assemble this table

**Step 1** Attach the I Plate "F" to the top of the legs, by using wood screws "G".

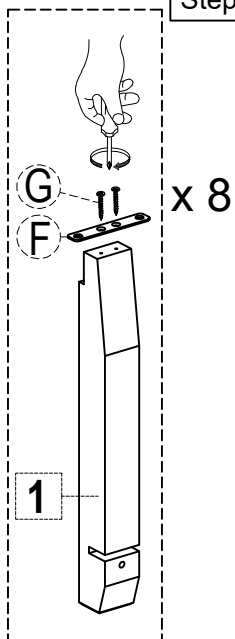

**Step 2** Attach the legs to the shelf, then position the legs inside the top frame and attach as shown.

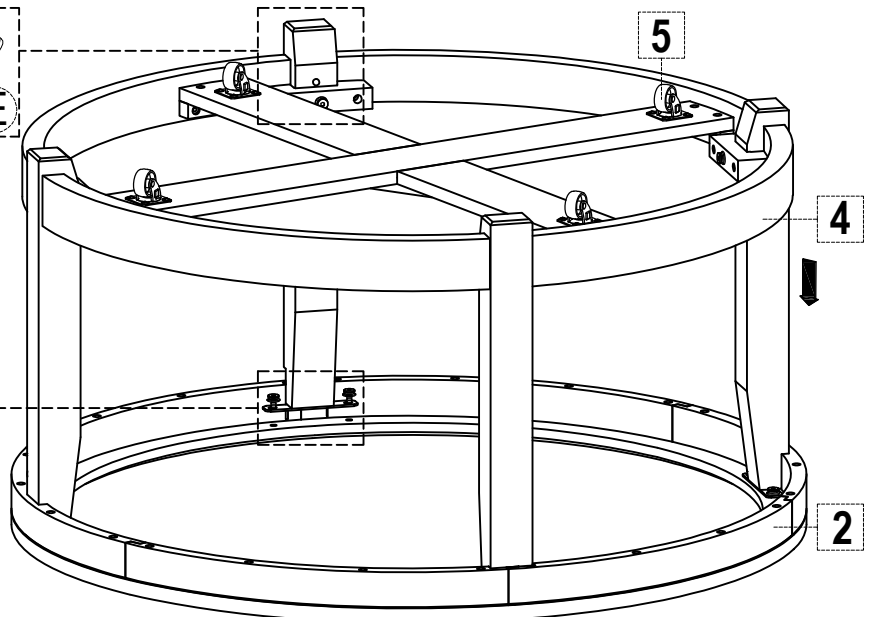
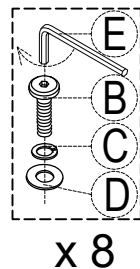
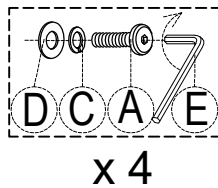

### FINISH

Carefully lay the Glass Insert in place

