





Thank you for purchasing this quality product. Be sure to check all packing material carefully for small parts that may have come loose inside the carton during shipment

Key Parts			
No	Code	Qty	Description
1		1 pc	Table top
2		4 pcs	Leg
3	1981P01L	4 pcs	Floor Leveler

Hardware kit (1981P01)			
No		Description	Qty
A		Flat washer	8 pcs
B		Lock washer	8 pcs
C		Bolt 8x30mm	8 pcs
D		Key wrench	1 pc

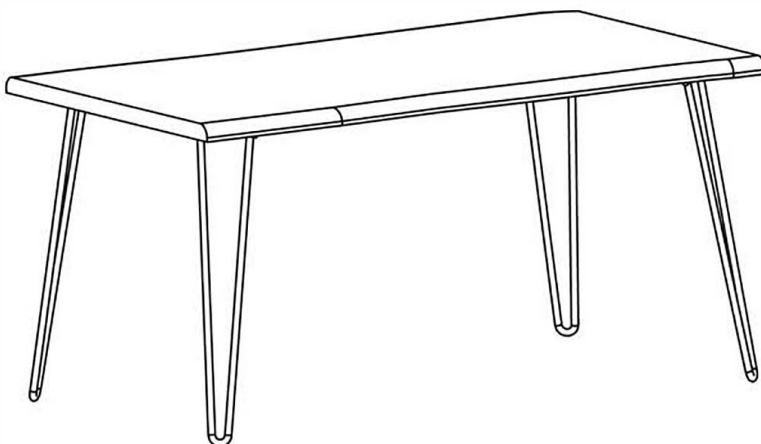
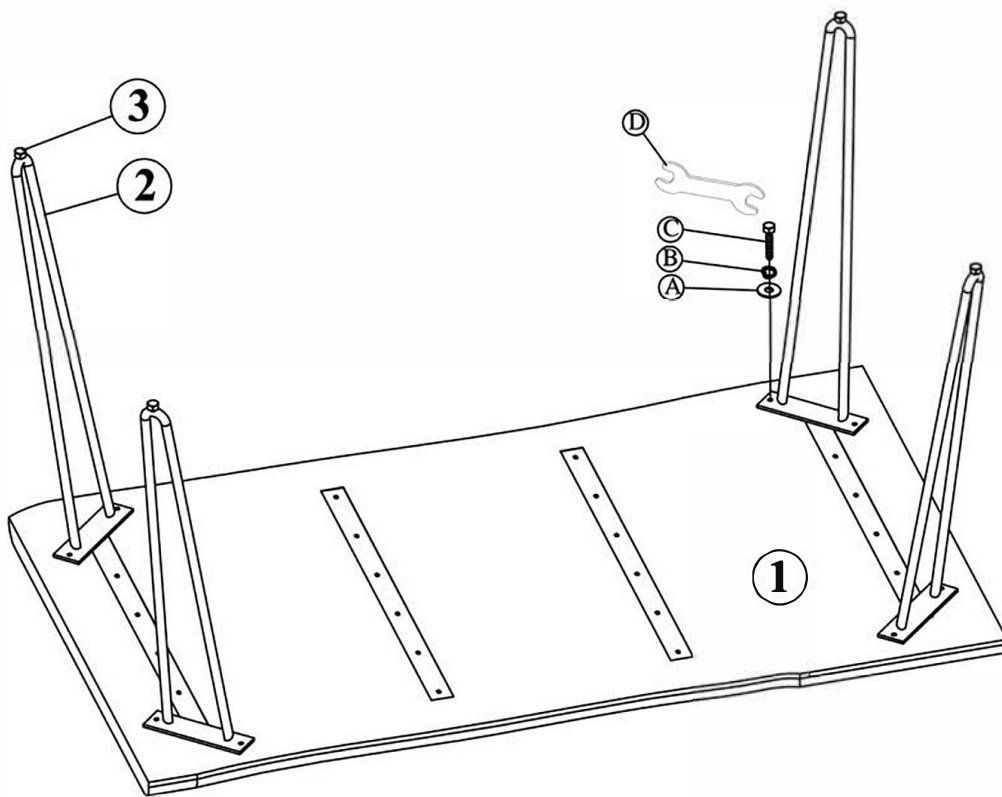

ASSEMBLY INSTRUCTIONS & PARTS IDENTIFICATION

2271-OWENCHJD

JADE

JOFRAN INC.

Hardware kit (2271-OWENCHP46)

Ltr	Qty	Description
A	9PCS.	BOLT ØM6X16MM
B	4PCS.	BOLT ØM6X28MM
C	4PCS.	FLAT WASHER
D	1PC	ALLEN WRENCH

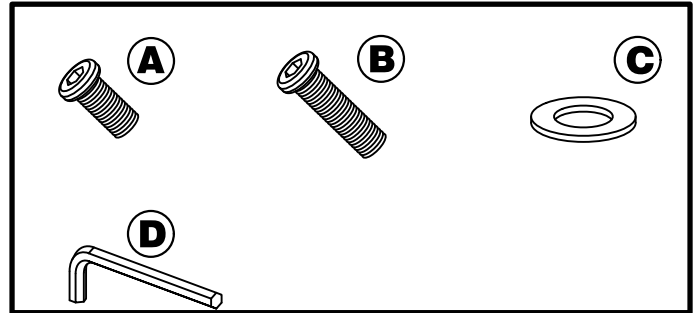

STEP 1:

- . Attach the leg assembly to the seat by inserting a flat washer and short bolt A per the diagram.
- . Attach the back rest frame to the seat by inserting short bolt A per the diagram.
- . Do not fully tighten at this point.

Parts Key

No	Code	Qty	Description
1	2271-OWENCHP42B	1PC	LEG ASSEMBLY
2	2271-OWENCHP40	1PC	BACK FRAME
3	2271-OWENCHJDP40C	1PC	BACK CUSHION
4	2271-OWENCHJDP41C	1PC	SEAT CUSHION
5	2271-OWENP01L	4PCS	LEVELER

STEP 2:

STEP 1:

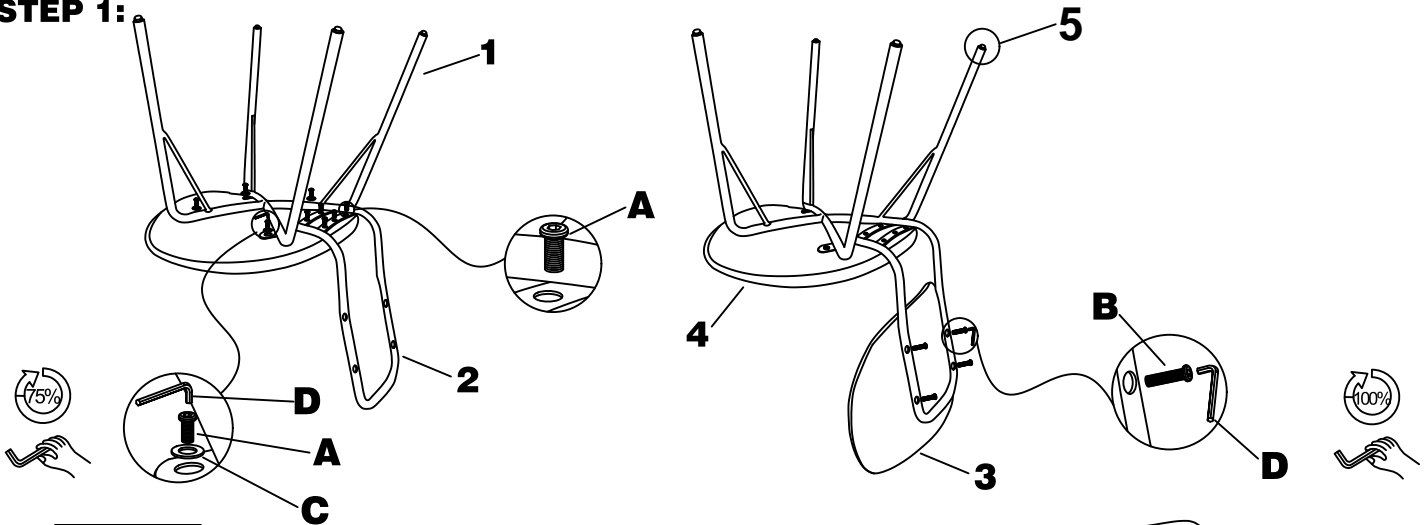

STEP 2:

- . Attach the backrest cushion to the backrest frame by inserting longer bolt B per the diagram.
- . Do not fully tighten the bolts until all are in place.
- . Once all bolts are in place, fully tighten the bolts by hand using the provided Allen Wrench. DO NOT use a power tool to tighten.
- . Use the floor levelers to level the chair, if needed.

*** FABRIC CARE:

Avoid direct sunlight, water, oil, acid, sharp objects etc.
 Use vacuum cleaner to clean. Wipe spills immediately.
 If needed, spot clean with a mild water-based soap.
 Fabric content 100% Polyurethane, Cleaning Code W

