









Thank you for purchasing this quality product. Be sure to check all packing material carefully for small parts that may have come loose inside the carton during shipment.

Hardware kit (1921-54KDP46)			
No	Description		Q'Ty
A		Hexa Nut Ø5/16"	4 pcs
B		Lock Washer 5/16"	14 pcs
C		Flat Washer 5/16"	14 pcs
D		Long Bolt 1/4"x 3 11/32"	4 pcs
E		Medium Bolt 1/4"x 1 3/4"	2 pcs
F		Short Bolt 1/4"x 1 3/8"	4 pcs
G		Allen Key	1 pc
H		Key Wrench	1 pcs
I		Screw Ø4 x 38mm	10 pcs

Key Parts			
No	Code	Description	Q'Ty
1	1921-54KDP40	Bench Back	1 pc
2	1921-54KDP41	Complete Seat	1 pc
3	1921-54KDP42	Right Front Leg	1 pc
4	1921-54KDP43	Left Front Leg	1 pc
5	1921-54KD42M	Middle Front Leg	1 pc
6	1921-54KDP44	Right Stretcher	1 pc
7	1921-54KDP45	Left Stretcher	1 pc
8	1921-54KDP49C	Center Stretcher	1 pc
9	1921-54KDP49	Front Stretcher	2 pcs
10	1921P01F	Floor glide	6 pcs

### STEP 1

- Carefully lay Chair Back flat on a smooth surface to prevent scratches.
- Affix Complete Seat to Chair Back by inserting a Flat Washer (C), Lock Washer (B) with Short Bolt (F) into each of the hole on the back rail of the seat, and Long Bolt (D) with washes into each of 2 holes in the Complete Seat corners. (See Detail A & B).
- Tighten screws with provided Allen Key (G) by turning clockwise until secure.

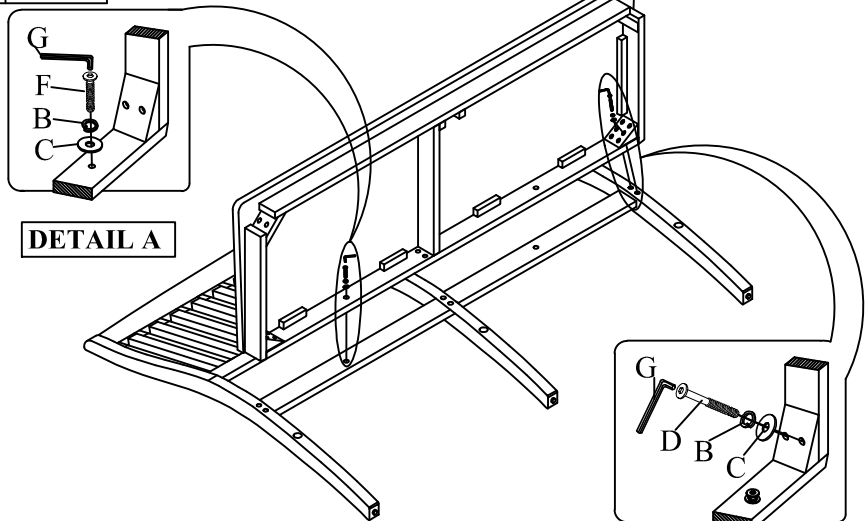

### STEP 2

- Carefully turn chair upside down and attach Corner Front Legs to the front corner of the Complete Seat. (Keeping in mind of the right and left leg) with a Flat Washer (C), Lock Washer (B) and Nut (A). (See detail C). Keep Bolt loose at this point. Insert right stretcher and left side stretcher between the Front and Back Legs.
- Position the Middle stretcher into the Back Middle Leg. Position the Middle Front Leg into place and two front stretcher between the corner Front Legs and the Middle Front Leg. Secure the Middle Leg with a Flat Washer (C), Lock Washer (B) and Medium Bolt (E) (See detail (D)). Keep bolts loose at this point.
- Fasten Stretchers to legs with Screws (I) using a Screwdriver (not provided).
- Tighten all bolts for the front legs.

