

5-Pack Hardware Kit (1885PO1) Table Hardware

Ltr	Qty	Description
A	8 pcs	Flat Washer
B	8 pcs	Lock Washer
C	8 pcs	Nut 5/16"
D	1 pc	Key Wrench

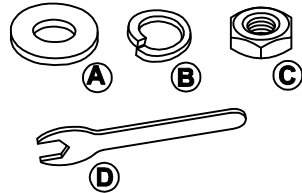
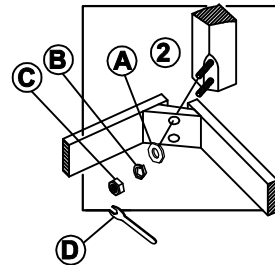
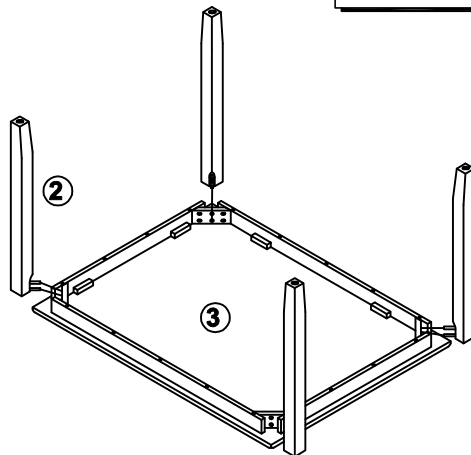

Table Parts Key

No	Code	Qty	Description
1	1885P01FT	4 pcs.	TableFloor Glide
2		4 pcs.	Leg
3		1 pc.	Table top



Detail A



STEP 1

- Carefully lay table top upside down on a smooth flat surface to prevent scratches.
- Affix a leg to each corner of the table top as shown in Detail A using a flat washer, lock washer and nut.
- Once all legs are in place, fully tighten the nuts

5-Pack Hardware Kit (1885P46) Chair Hardware

Ltr	Qty	Description
A	44 pcs.	Flat Washer 5/16"
B	44 pcs.	Lock Washer 5/16"
C	16 pcs.	Nut 5/16"
D	1 pc.	Key Wrench
E	16 pcs.	Long KD. Bolt 1/4"x 3".
F	12 pcs.	Short KD. Bolt 1/4"x 1.5".
G	1 pc.	Allen Wrench

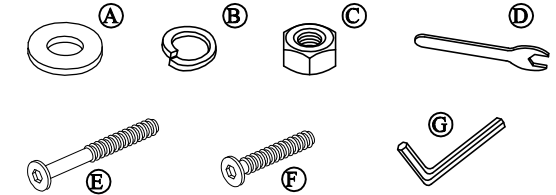

Chair Parts Key

No	Code	Qty	Description
5	1885P01FC	16 pcs.	Chair Floor Glide
6		4 pcs.	Chair Back
7	1885P41	4 pcs.	Complete Seat
8	1885P42	8 pcs.	Front Leg

* Quantities noted are for a total of four chairs.

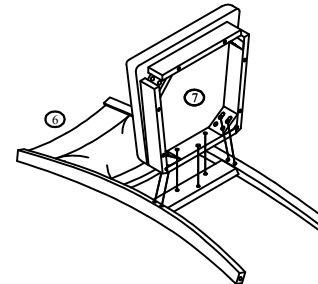

STEP 1

- Carefully lay chair back flat on a smooth flat surface to prevent scratches.
- Affix the complete seat to chair back, as shown in Detail A, using a flat washer, lock washer and short KD bolt.
- Secure complete seat to chair back corners, as shown in Detail B, using a flat washer, lock washer and long KD bolt. - - Tighten screws with provided Allen Wrench.

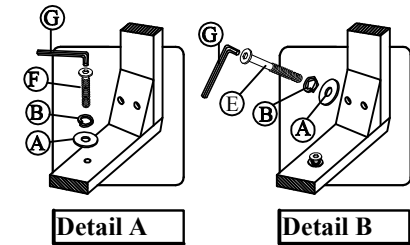

Detail A

Detail B

FABRIC CARE INSTRUCTION REGULAR CARE:
Clean with shampoo, foam, or dry cleaning solvents as desired. Do not saturate with liquid. Pile fabrics may require brushing to restore appearance. Cushion covers should not be removed and dry cleaned.
FABRIC CONTENT
100% Polyester; Cleaning code "WS"

STEP 2

- Carefully turn chair upside down and affix each Leg to the front corner of the complete seat, as shown in Detail C, using a flat washer, lock washer, and nut.
- Turn chair upright and make sure it is level before fully tightening all bolts and nuts.
- Be sure to tighten all screws prior to using chair.

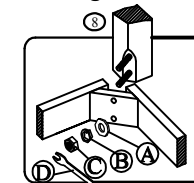

Detail C

