

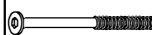







Thank you for purchasing this quality product. Be sure to check all packing material carefully for small parts that may have come loose inside the carton during shipment.

Hardware kit (1872-54TP01)			
No	Description	Q'Ty	
A	 Long Bolt Ø8 x 180mm	8 pcs	
B	 Short Bolt Ø6 x 35mm	20 pcs	
C	 Lock washer	32 pcs	
D	 Flat washer	32 pcs	
E	 Hexa Nut Ø8	4 pc	
F	 Screw Knob	2 pcs	
G	 Knob	2 pcs	
H	 Wrench key	1 pc	
I	 Allen Key Ø4	1 pc	

Parts Key			
No	Code	Description	Q'Ty
1		Table Top	1 Pc
2	1872-54BP08T	Storage Box Top Panel	1 Pc
3	1872-54BP08B	Storage Box Bottom Panel	1 Pc
4	1872-54BP08S	Storage Box Side Panel	2 Pcs
5	1872-54BP07	Storage Box Door	2 Pcs
6		Legs	4 Pcs
7	1872-54BP01D	Door Catch Assembly	2 Sets
8	1872-54BP07H	Door Hinge	4 Pcs
9	1872-54BP04	Pull w/Screw	2 Sets
10	1872-54BP01F	Floor Glide	4 Pcs
11	1872-54TP01A	Apron Spacer	4 Pcs
12	1872-54TP13	Extension Mechanism	1 Sets
13	1872-54TP29	Mounting Plate	2 Pcs
14	1872-54TP01AH	Apron Hinge	4 Pcs
15	1872-54TP01AP	Leaf Apron	2 Pcs
16	1872-54TP01H	Leaf Hinge	2 Pcs
17	1872-54TP13L	Extension Lock	4 Sets
18	1872-54TP24SP	Bottom Support Panel	2 Pcs
19	1872-54TP26S	Swing Hinge	2 Pcs
20	1872-54TP36	Leaf Support	1 Pc
21	1872-54TP02E	Leg Extension	4 Pcs

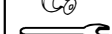
#### STEP 1

- Carefully place the Leg on the smooth surface.
- Position the Side Panel into designated location of the Leg as shown. Insert the Bolts (B), with Lock Washers (C) & Flat Washer (D), through pre-drilled holes in wood cleat of Side Panel. Tighten securely with the Allen Key (I). (See Detail A).
- Do the same with other Legs and Side Panel.

#### STEP 2

- Turn the Side frame (assembled in step 1) upright, position the Door frame onto designated location of the Side frame as shown. Insert the Bolts (B) with Lock Washers (C) & Flat Washer (D) through pre-drilled holes in wood cleat of Door Frames and attach to the assembled Side Frame from Step 1
- Attach the bottom panel to the underside of the base by inserting Bolts (B) with Lock Washers (C) and Flat Washers (D) through the predrilled holes in the bottom panel and attach to the cleats on the inside of the side panel.
- Carefully turn the Storage Box to the upright position, insert the Top Panel (2) Between the legs (See Detail B).

DETAIL A

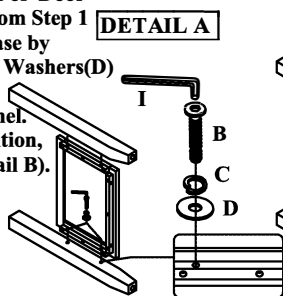

DETAIL B

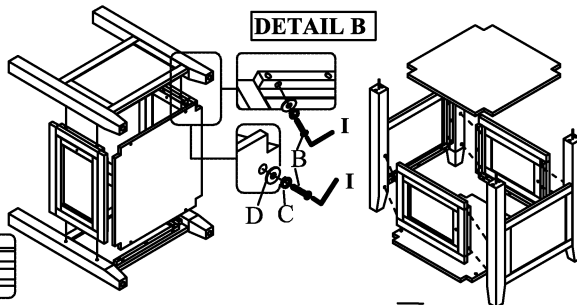

#### STEP 3 FOR COUNTER HEIGHT TABLE ONLY

- Insert Long bolt (A) with Flat washer (D), Lock washer (C) through the leg extension and tighten securely with the Allen key (I). (See Detail C).

#### STEP 4

- Position the Table top into designated locations of the Storage Box.
- Insert the Hexa nut (E) with Lock Washers (C) & Flat Washer (D) into the fixed bolts of the leg. Tighten securely with Wrench (H).
- Affix Knob (G) to the Door, tightening the screw with a phillips-head screwdriver (not provided). (See Detail D)

DETAIL C

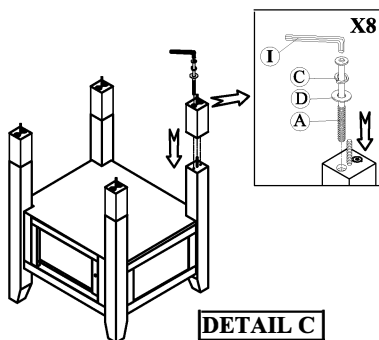

DETAIL D

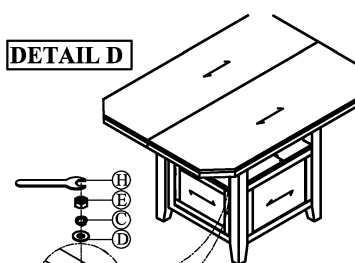

DETAIL E

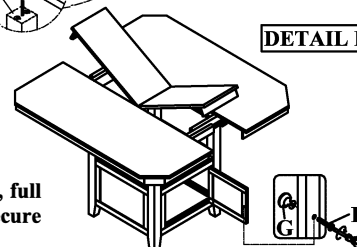

#### SELF STORING LEAF

Fully extend both sides of the table and carefully swing over folded butterfly leaf unfold to lay flat, full extended, in line with table top. Unfold leaf aprons and carefully close table top with leaf in place. secure leaf with extension locks on the underside of table. Reverse procedure for storage. (See Detail E)