





Thank you for purchasing this quality product. Be sure to check all packing material carefully for small parts that may have come loose inside the carton during shipment.

Parts Key			
No	Code	Q'ty	Description
1	1744-7P02	4 Pcs.	Leg
2	1744-7P05	1 Pc.	Drawer Complete
3	1744-7P08	1 Pc.	Shelf
4	1744P01F	4 Pcs.	Floor glide
5	1744P04	1 Set.	Knob w/screw
6	1744-7P06	2 Pcs.	Drawer glide
7	1744P05A	1 Set.	Drawer stop

Hardware Kit 1744-7P01			
No		Description	Q'ty
A		Lock washer Ø8 x 13mm	12 Pcs.
B		Flat washer Ø8 x 19mm	12 Pcs.
C		Bolt Ø8 x 60mm	12 Pcs.
D		Allen key	1 Pc.

STEP 1 :

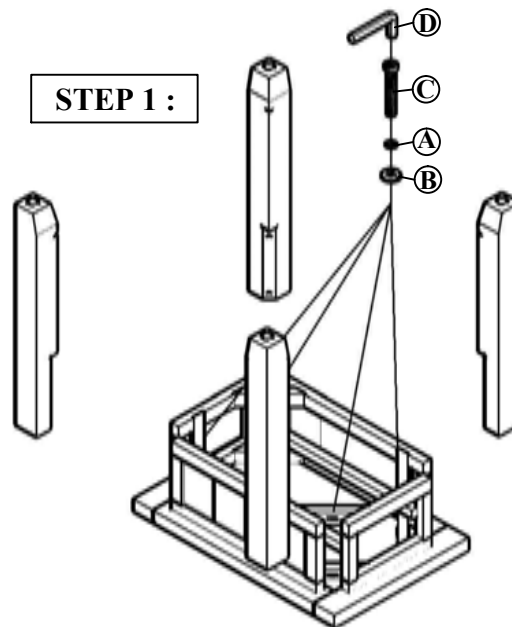

STEP 2 :

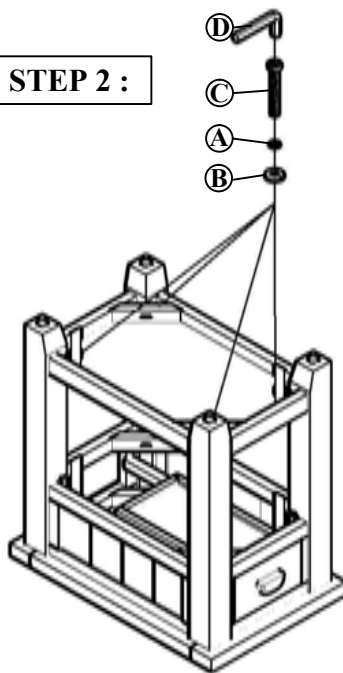

STEP 3 :

