

Thank you for purchasing this quality product. Be sure to check all packing material carefully for small parts that may have come loose inside the carton during shipment.

Parts key							
No	Code	Qty	Description	No	Code	Qty	Description
1	1744-70 P05U	1 Pcs.	Upper Drawer Complete	9	1744 P01D	2 Sets.	Door Catch
2	1744-70 P05L	1 Pc	Lower Drawer Complete	10	1744 P07H	4 Sets.	Door Hinge
3	1744 P04	3 Sets.	Drawer Pull w/Screws	11	1744-70 P08	2 Pc.	Shelf
4	1744 P06	2 Sets.	Drawer Glide	12	1744 P08P	8 Pcs.	Shelf Pin
5	1744 P05A	2 Sets	Drawer Stop	13	1744 P01F	4 Pcs	Floor Glide
6	1744-70 P07R	1 Pc.	Right Facing Door	14	1744 P01AT	1 Set.	Anti-tip kit
7	1744-70 P07L	1 Pc.	Left Facing Door	15	1744 P01L	1 Pc	<b>Floor Leveler</b>
8	1744 P04A	2 Sets.	Door Pull w/Screw				

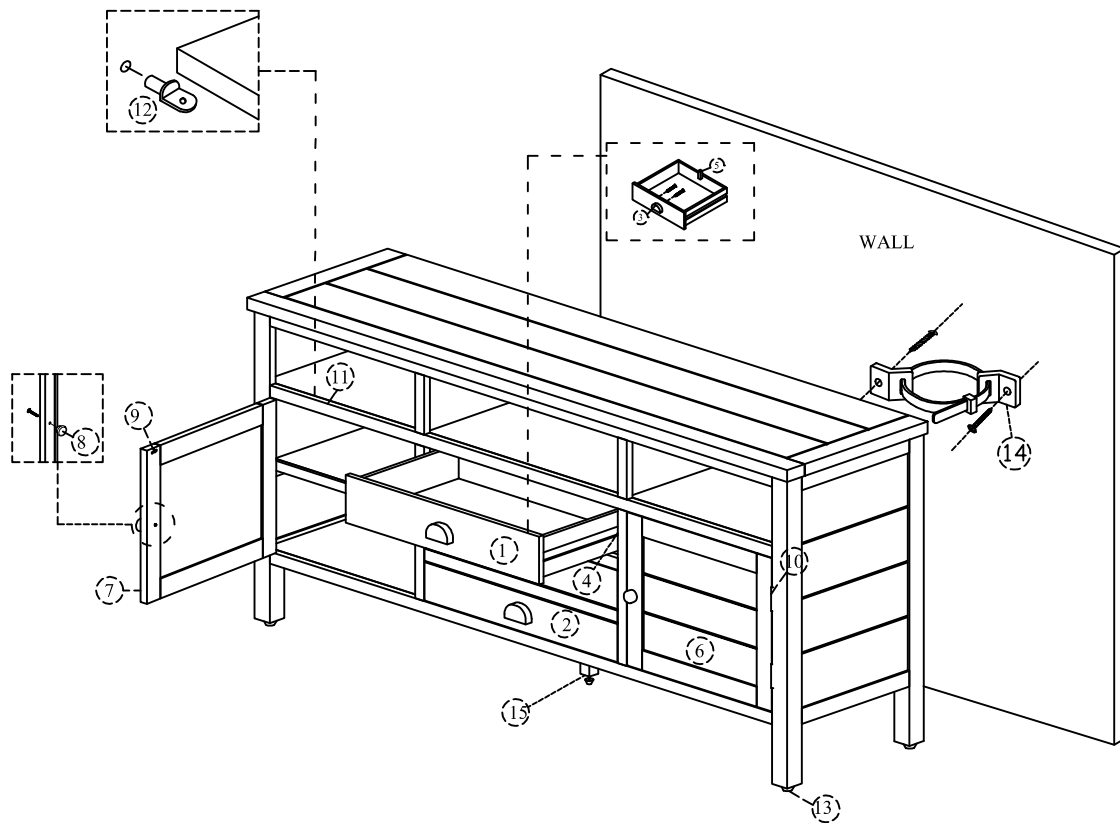

### STEP :

- Carefully Turn Media Unit Upright ( 2 People Recommended To Do So ).
  - Insert Shelf Pins Into Locations Of Desired Shelf Height Using 4 Pins Per Shelf.
  - Set Shelf Upon Secured Shelf Pins.
  - Install Drawer Into Designated Locations As Shown In Diagram.
  - Affix Pull To The Drawers And Doors Using Small Kd. Screw, Tightening With A Phillipshead Screwdriver ( Not Provided).
- Please Note : To Help Prevent The Possibility Of Tip-over, Install The Anti-tip Over Restraint Provided.**