

Thank you for purchasing this quality product. Be sure to check all packing material carefully for small parts that may have come loose inside the carton during shipment.

Parts key			
No	Code	Qty	Description
1	1744-58 P05SU	2 Pcs.	Upper Side Drawer
2	1744-58 P05SL	2 Pcs.	Lower Side Drawer
3	1744-58 P05	1 Pc.	Center Drawer
4	1744 P04	4 Pcs.	Drawer Pull W/screws-side
5	1744 P04A	1 Pc.	Drawer Pull W/screws-center
6	1744-58P06	5 Sets.	Drawer Glide
7	1744-58 P02	4 Pcs.	Leg
8	1744 P01F	4 Pcs.	Floor Glide
9	1744-58 P05A	5 Pcs.	Drawer Stop

Hardware Kit (1744-58 P01)			
No	Description		Qty
A		Lock Washer Ø8	8 pcs
B		Flat Washer Ø8	8 pcs
C		Short Bolt Ø8 x 70mm	8 pcs
D		Allen Key	1 pc

Attach Legs Using a Bolt (C), Lock Washer (A)
And A Flat Washer (B). Fully Tighten With Allen
Key Provided

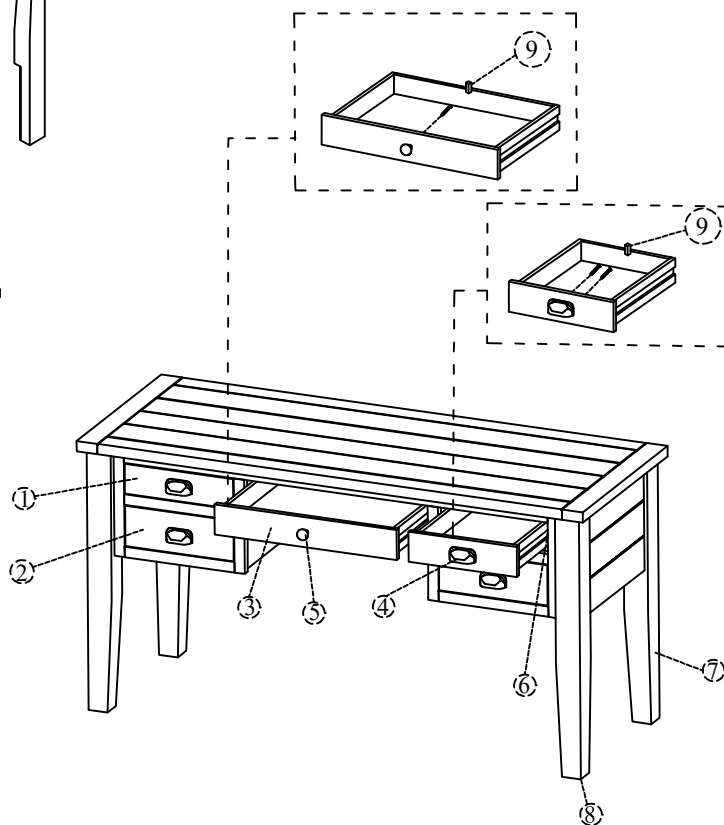
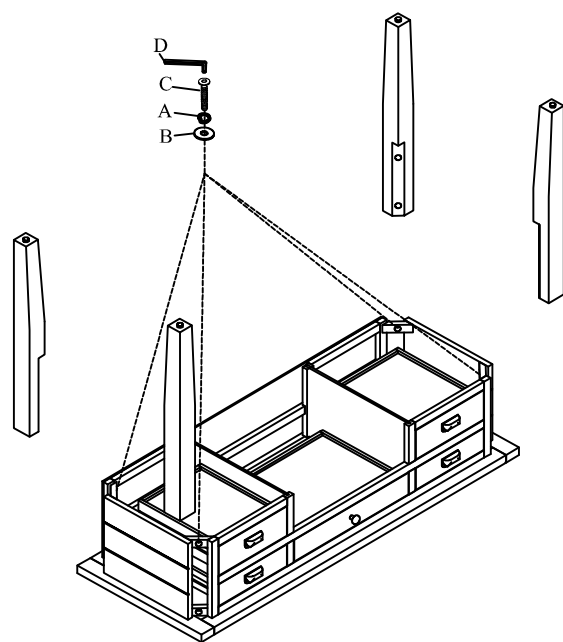

Carefully turn desk to the upright
position using two persons