

Thank you for purchasing this quality product. Be sure to check all packing material carefully for small parts that may have come loose inside the carton during shipment.

Parts key

No	Code	Qty	Description	No	Code	Qty	Description
1	1744-54 P05	2 Pcs.	Drawer	8	1744 P01D	2 Sets.	Door Catch
2	1744 P04	2 Sets.	Drawer Pull w/Screw	9	1744 P07H	4 Sets.	Door Hinge
3	1744-54 P06	2 Sets.	Drawer Glide	10	1744-54 P08	2 Pc.	Shelf
4	1744 P05A	2 Sets	Drawer Stop	11	1744 P01F	4 Pcs.	Floor Glide
5	1744-54 P07R	1 Pc.	Right Facing Glass Door	12	1744 P01AT	1Sets	Anti-tip kit
6	1744-54 P07L	1 Pc.	Left Facing Glass Door	13	1744 P08P	8 Pcs.	Shelf Pin
7	1744 P04A	2 Sets.	Door Pull w/Screw				

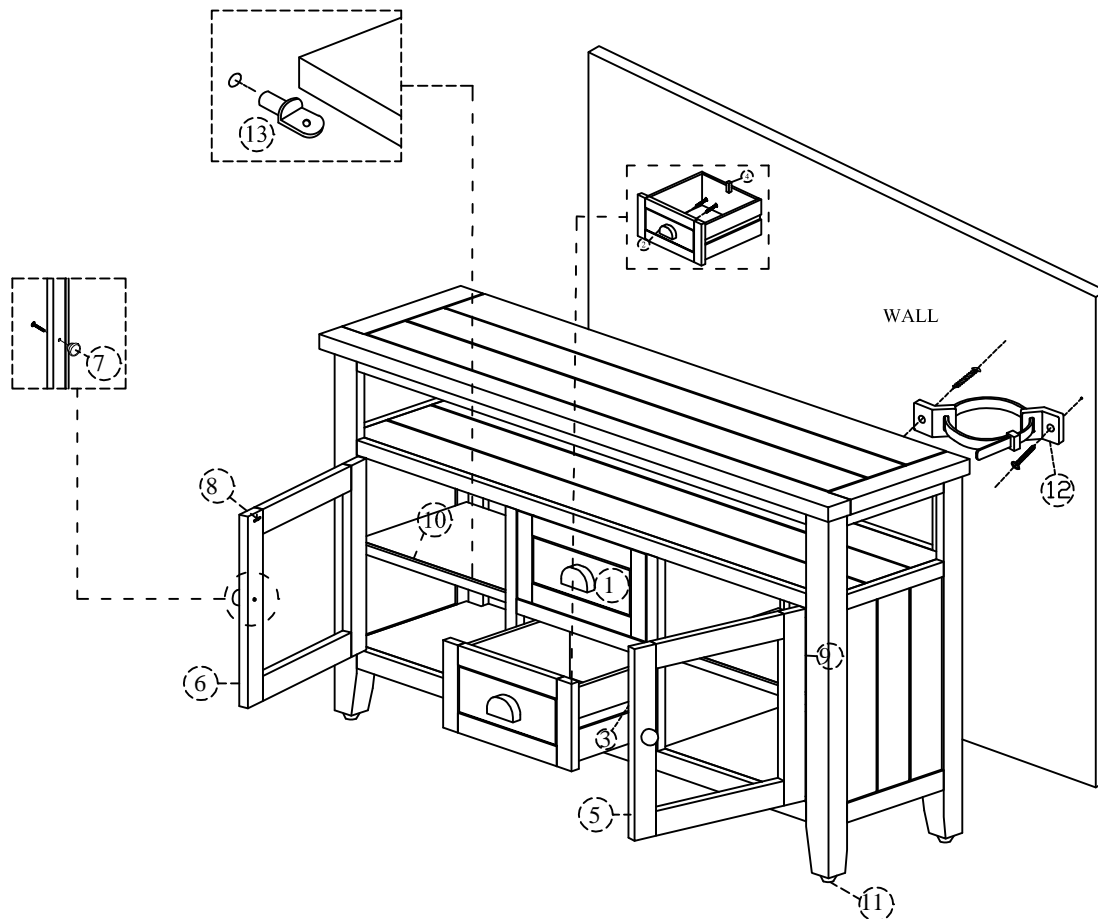

STEP :

- Carefully Turn Media Unit Upright (2 People Recommended To Do So).
 - Insert Shelf Pins Into Locations Of Desired Shelf Height Using 4 Pins Per Shelf.
 - Set Shelf Upon Secured Shelf Pins.
 - Install Drawer Into Designated Locations As Shown In Diagram.
 - Affix Pull To The Drawers And Doors Using Small Kd. Screw, Tightening With A Phillipshead Screwdriver (Not Provided).
- Please Note : To Help Prevent The Possibility Of Tip-over, Install The Anti-tip Over Restraint Provided.