

Thank you for purchasing this quality product. Be sure to check all packing material carefully for small parts that may have come loose inside the carton during shipment.

Parts key

No	Code	Qty	Description	No	Code	Qty	Description
1	1744-32 P05	3 Pc.	Drawer	7	1744-32 P08	1 Pcs.	Shelf
2	1744 P04	3 Sets	Drawer Pull w/Screws	8	1744 P01F	4 Pcs.	Floor Glide
3	1744 P05A	3 Pc.	Drawer Stop	9	1744 P04A	1 Pc.	Door Pull W/screws
4	1744-32 P07	1 Pc.	Door	10	1744 P01AT	1 Set	Anti-tip Kit
5	1744 P01D	1 Pcs	Door Catch	11	1744 P08P	4 Pcs.	Shelf Pin
6	1744 P07H	2 Pcs	Door Hinge	12	1744-32P06	6 Pcs	Drawer Glide

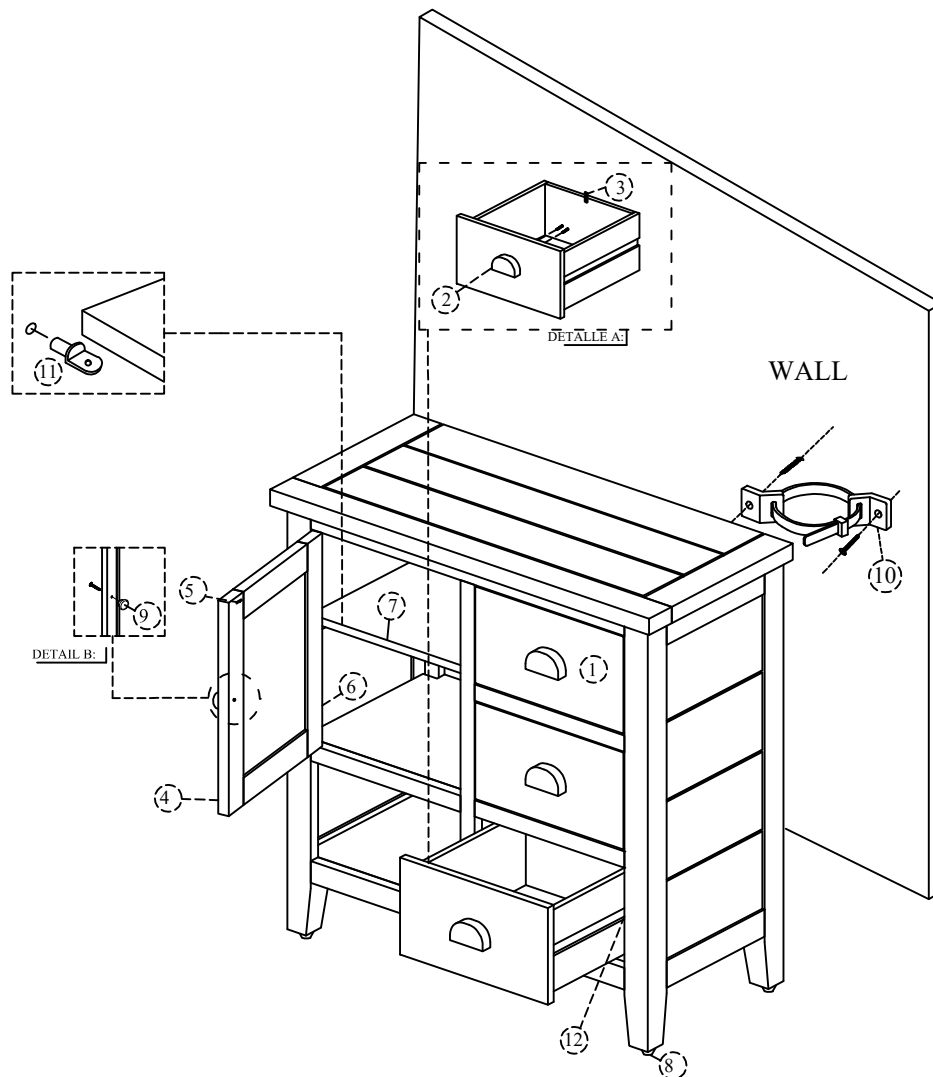

STEP :

- Carefully turn Accent cabinet upright (2 people recommended).
- Insert shelf pins into locations of desired shelf height using 4 pins per shelf.
- Set shelf upon secured shelf pins.
- Attach Pull to the drawers and doors using small kd. screw, tightening with a phillipshead screwdriver (not provided).

Please Note : To Help Prevent The Possibility Of Tip-over, Install The Anti-over Restraint Provided.