





Thank you for purchasing this quality product. Be sure to check all packing material carefully for small parts that may have come loose inside the carton during shipment

Key Parts			
No	Code	Qty	Description
1	1702-106P24	1 pc	Table Top
2	1702-106P02	4 pcs	Table Leg
3	1702-106P02M	1 pc	Middle Leg
4	1702P01F	4 pcs	Floor Glide
5	1702-106P13	2 pcs	Extension Mechanism
6	1702P13L	4 pcs	Extension Lock
7	1702-106P26	4 pcs	Corner Block
8	1702-106P01A	4 pcs	Apron Spacer
9	1702P01L	1 pc	Leveler
10	1702-106P29	1 pc	Mounting Board

Hardware kit 1702-106P01			
No		Description	Q'Ty
A		Hexa Nut Ø8	8 pcs
B		Lock Washer Ø8.5	8 pcs
C		Flat Washer Ø8.5	8 pcs
D		Key Wrench	1 pc

DETAIL A

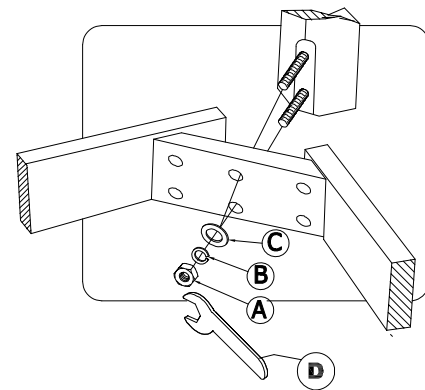

PLEASE NOTE:

Assembly of this table requires two people

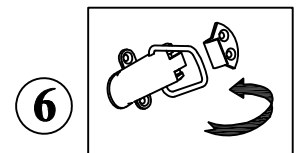
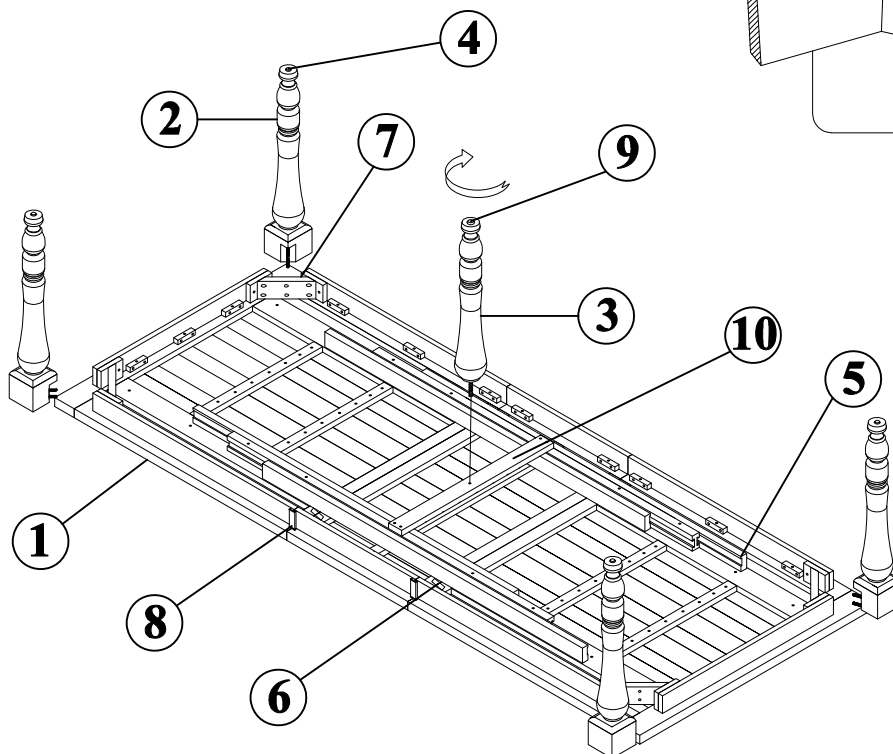

STEP 1

- Carefully lay Table Top upside down on a smooth flat surface to prevent scratches.
- Affix each Leg to each corner of the Table Top as shown in illustration. Insert a Flat Washer, Lock Washer and Nut on the bolts of each Leg (See Detail A)
- Once all Legs are in place, fully tighten nuts by turning clockwise using provided Key Wrench until secure.
- Attach the middle leg by screwing tightly into place and adjusting the leg leveler to meet the floor.

PLEASE NOTE:

- Two persons are required when opening and closing the table.
- Table must be lifted when moving to prevent stress on the middle leg.

