







Thank you for purchasing this quality product. Be sure to check all packing material carefully for small parts that may have come loose inside the carton during shipment

Parts key				Hardware kit #1690-9P01			
No	Code	Qty	Description	No	Description		Qty
1	1690-9P51	1 pc	Storage Box	A	 Hex Bolt	M6 x 35	6 pcs
2	1690-9P05	2 pcs	Drawer Complete	B	 Hex Bolt	M6 x 15	8 pcs
3	1690P04	2 sets	Pull w/Screws	C	 Nut Hex	M6 x 16	6 pcs
4	1690-9P05A	2 pcs	Drawer Stop	D	 Lock washer	M6	14 pcs
5	1690-9P06	4 pcs	Drawer Glide	E	 Flat washer	M6 x 16	20 pcs
6	1690-9P53	2 pcs	Leg assembly	F	 Screw	Ø4 x 15	6 pcs
7	1690-9P08	2 pcs	Shelf	G	 Wrench 10		2 pcs
8	1690P01L	4 pcs	Floor Leveler				
9	1690P01AT	1 set	Anti-tip kit				

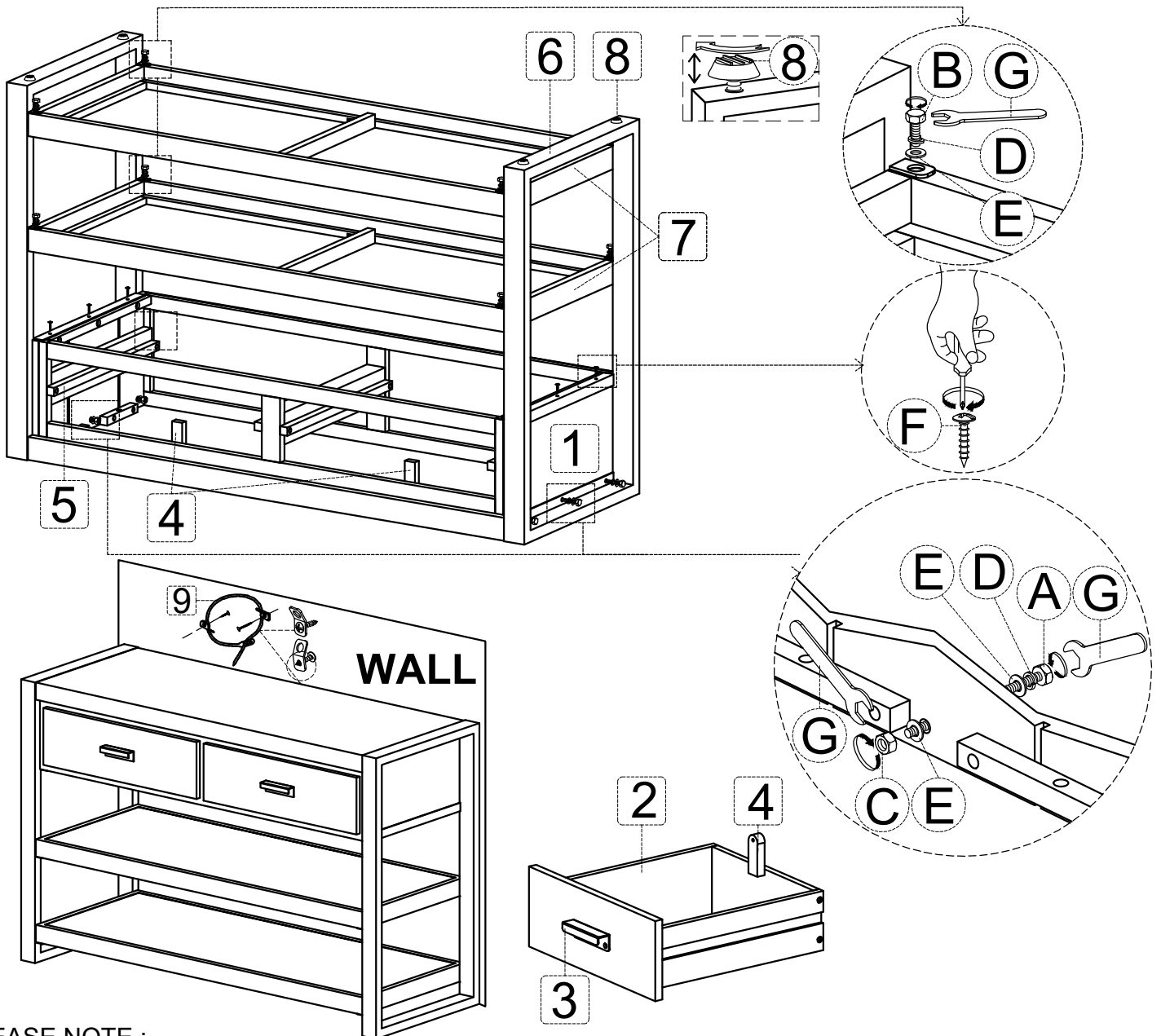

PLEASE NOTE :

To avoid the possibility of the furniture tipping and injury, the anti-tip hardware must be installed.