









No	Description	Code	Q'Ty
1	 Knob W/ Screw of Door	1550-50P04	2 sets
2	 Right facing door		1 pc
3	 Left facing door		1 pc
4	 Hinge	1550-50P07H	4 pcs

No	Description	Code	Q'Ty
5	 Leveler	1550-50P01L	3 pcs
6	 Floor Glide	1550P01F	2 pcs
7	 Upper Door catch set	1550P01DU	2 sets
8	 Lower Door catch set	1550P01DL	2 sets
9	 Anti Tip Kit	1550P01AT	1 set

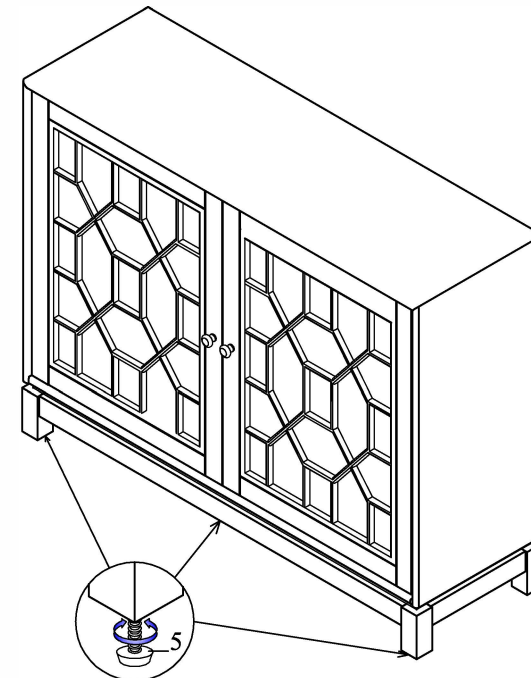
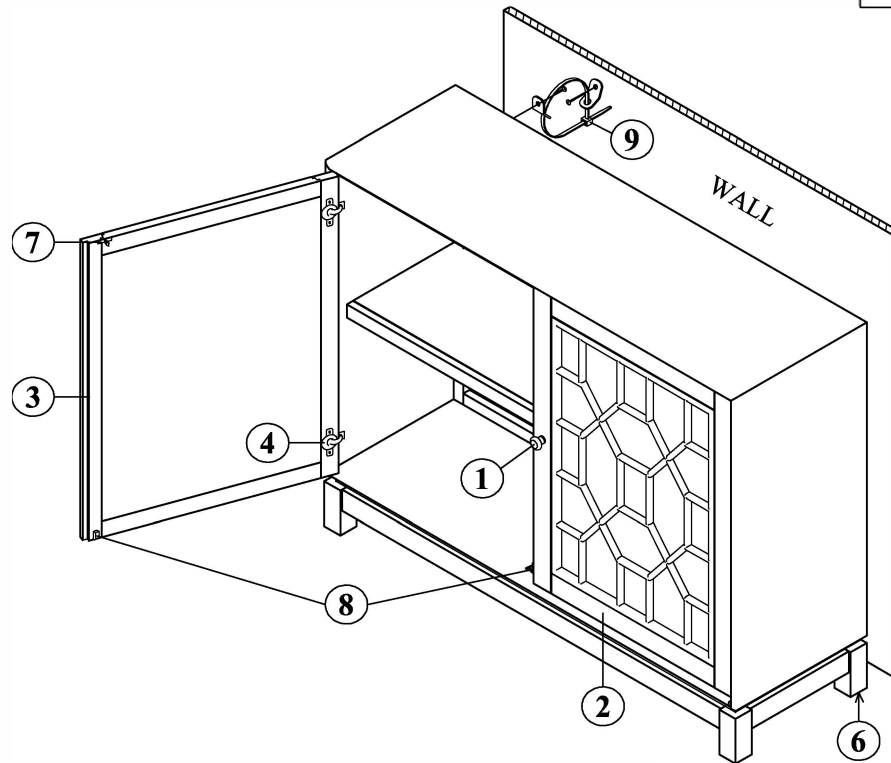

★ **PLEASE NOTE:** To help prevent the possibility of tip-over, install the tipover restraint provided.