



# Assembly Instruction





ITEM NO.:9360BEG-1PW  
Power reclining chair



Legs & hardware are stored at the bottom of the seat, please take out for assembly.

**Note: Do not use power tools for assembly. Power tools increase the risk of over tightening which lead to splitting or cracking the wood.**

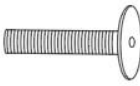
## Component list

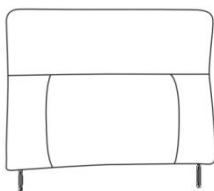
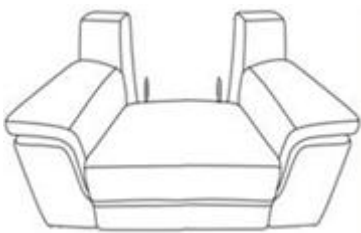
Label	Picture	QTY	Description
A		4 PCS	Metal leg H 5 1/2"
B		16 PCS	Metal Washer φ1/2 "
C		16 PCS	Bolt φ1/2"X1"
D		1 PC	Allen Key 2 1/4"X1"
E		1 PC	Back Rest
F		1 PC	Seat

## Step 1

Adaptor set is pre-connected and located under the seat, please take out the plug and wire for use.

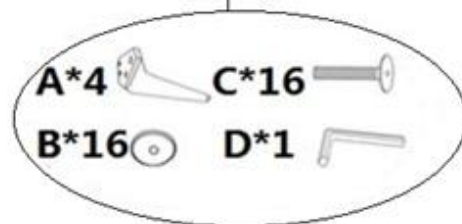

## Step 2

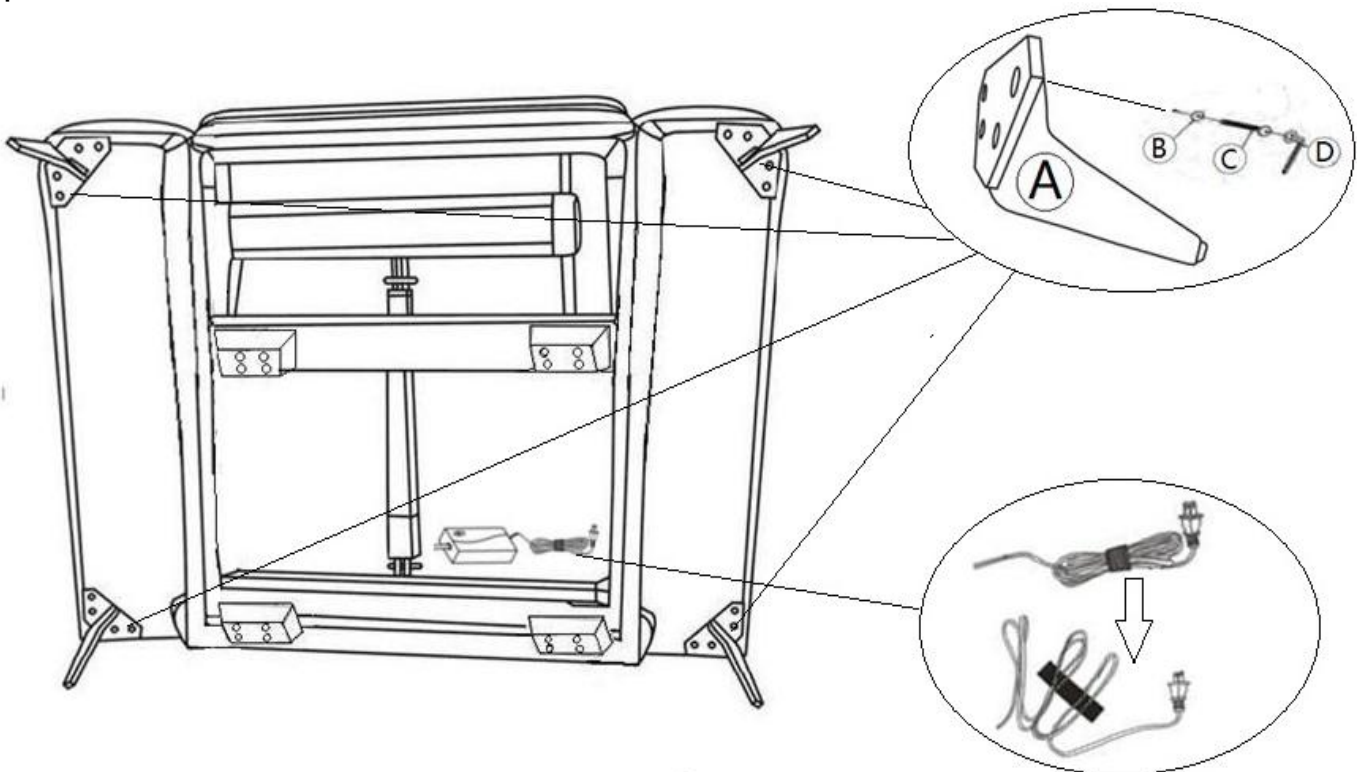

Remove the tape and untighten the plug with wire for use.

Step 3

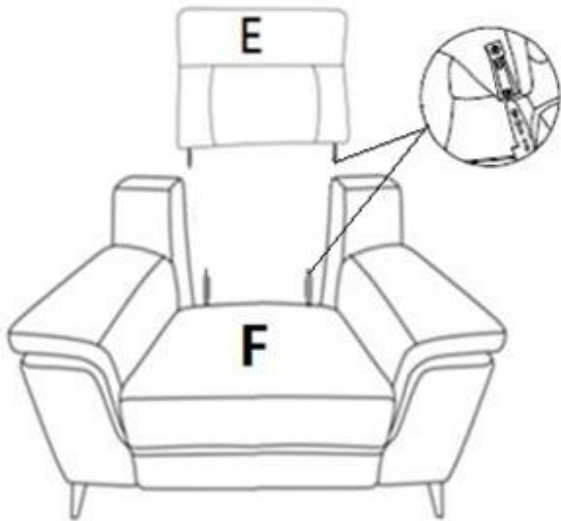

Step 4

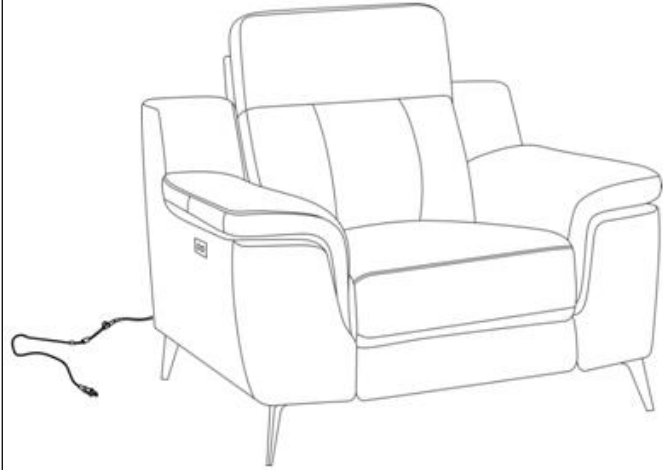

Step 5

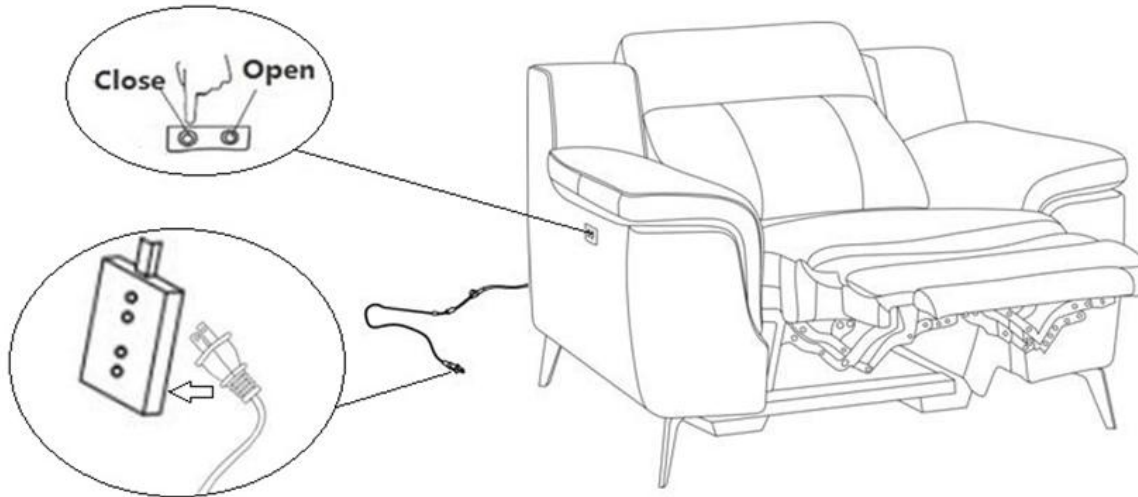

Put in to outlet to operate the unit.

**Care Instruction for Top Grain Leather Furniture:**

In order to maintain the original appearance of your Top Grain Leather furniture, please follow below simple care procedures:

- Avoid exposing furniture directly to sunlight or heating and air conditioning outlets. Sunlight and or exposure to heating and air conditioning outlets will fade/damage top grain leather.
- Vacuum or wipe with a soft cloth to remove dust.



For item use on wooden floor, hard surfaces or carpets, it is recommended to install protective pads under all legs and supports to avoid/prevent from damages/scratches and discoloration.

**Warning**

Do not allow electrical cord to be pinched between moving parts or between the frame and the floor. Do not place cord under carpet or in location where it could become worn.