

ASSEMBLY INSTRUCTION

HOME ELEGANCE

2601-48/2601BK-48 METAL TABLE, FAUX MARBLE TOP (PAPER)

PART LIST:

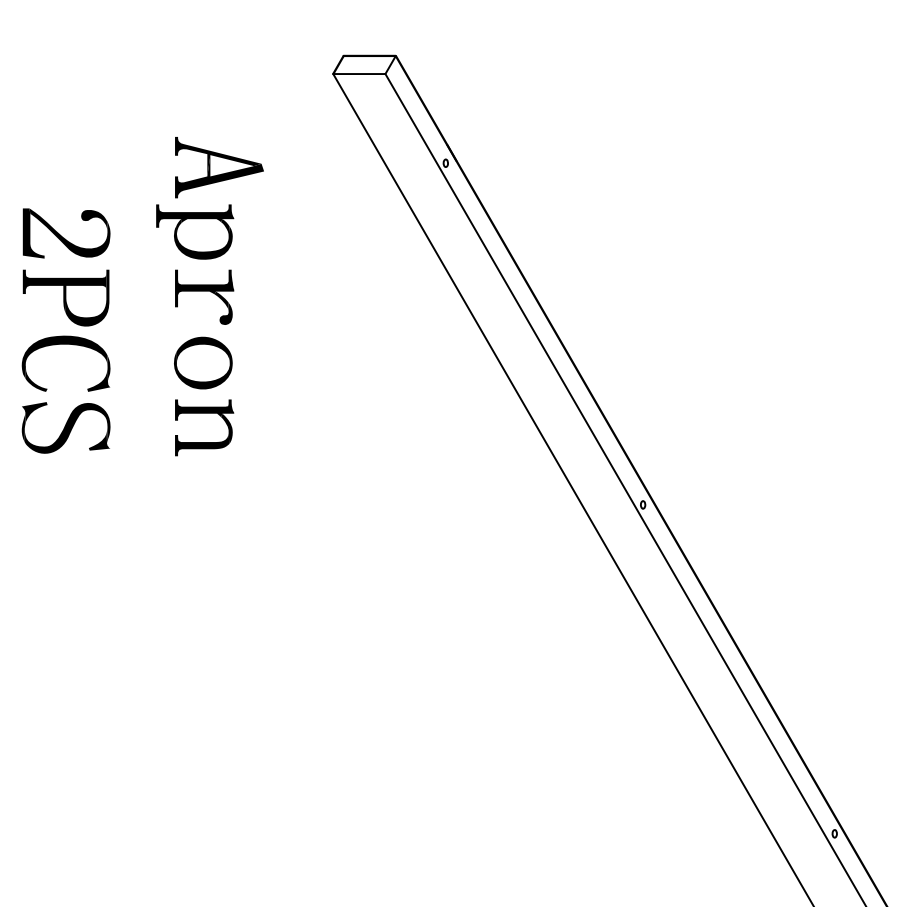
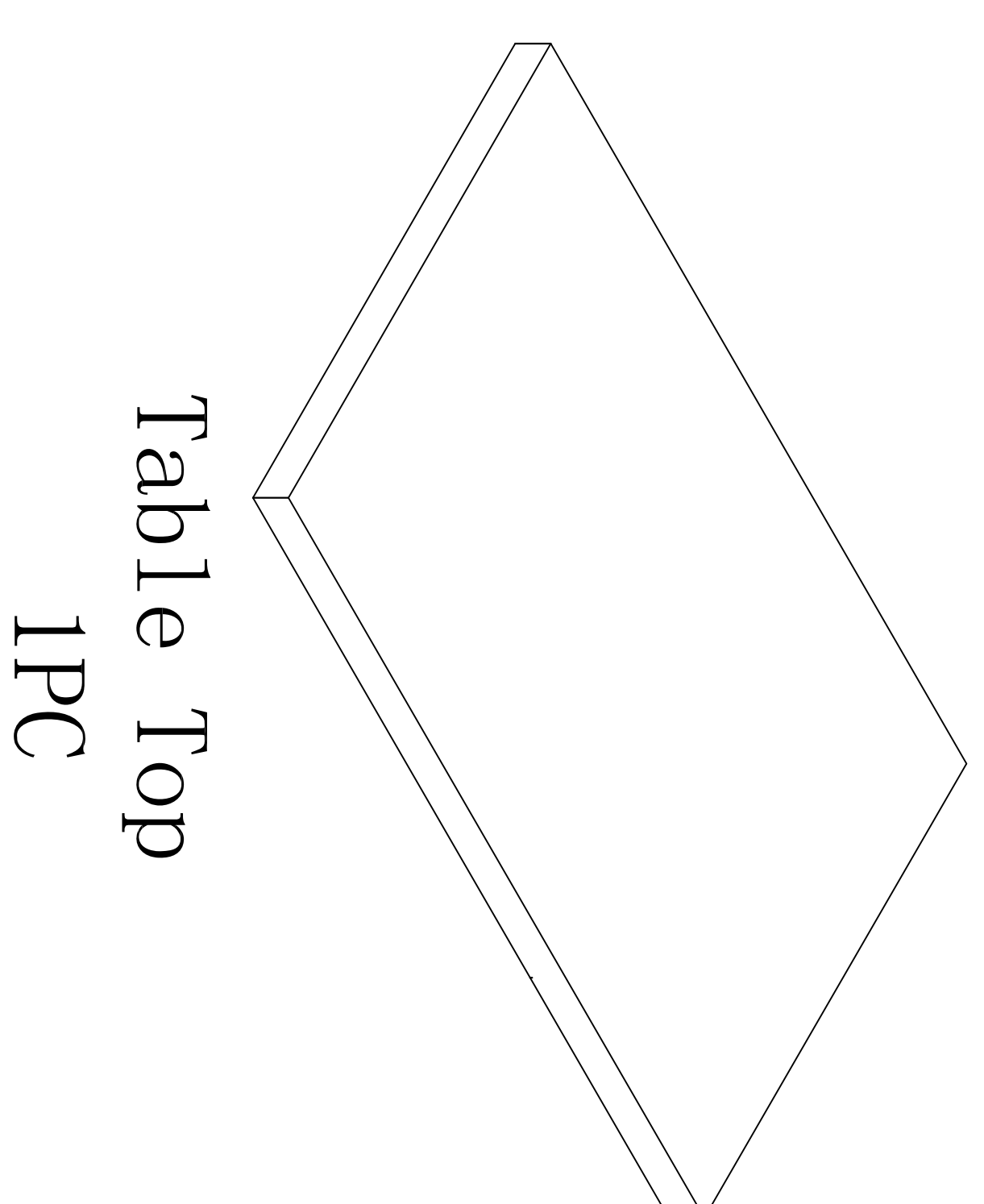
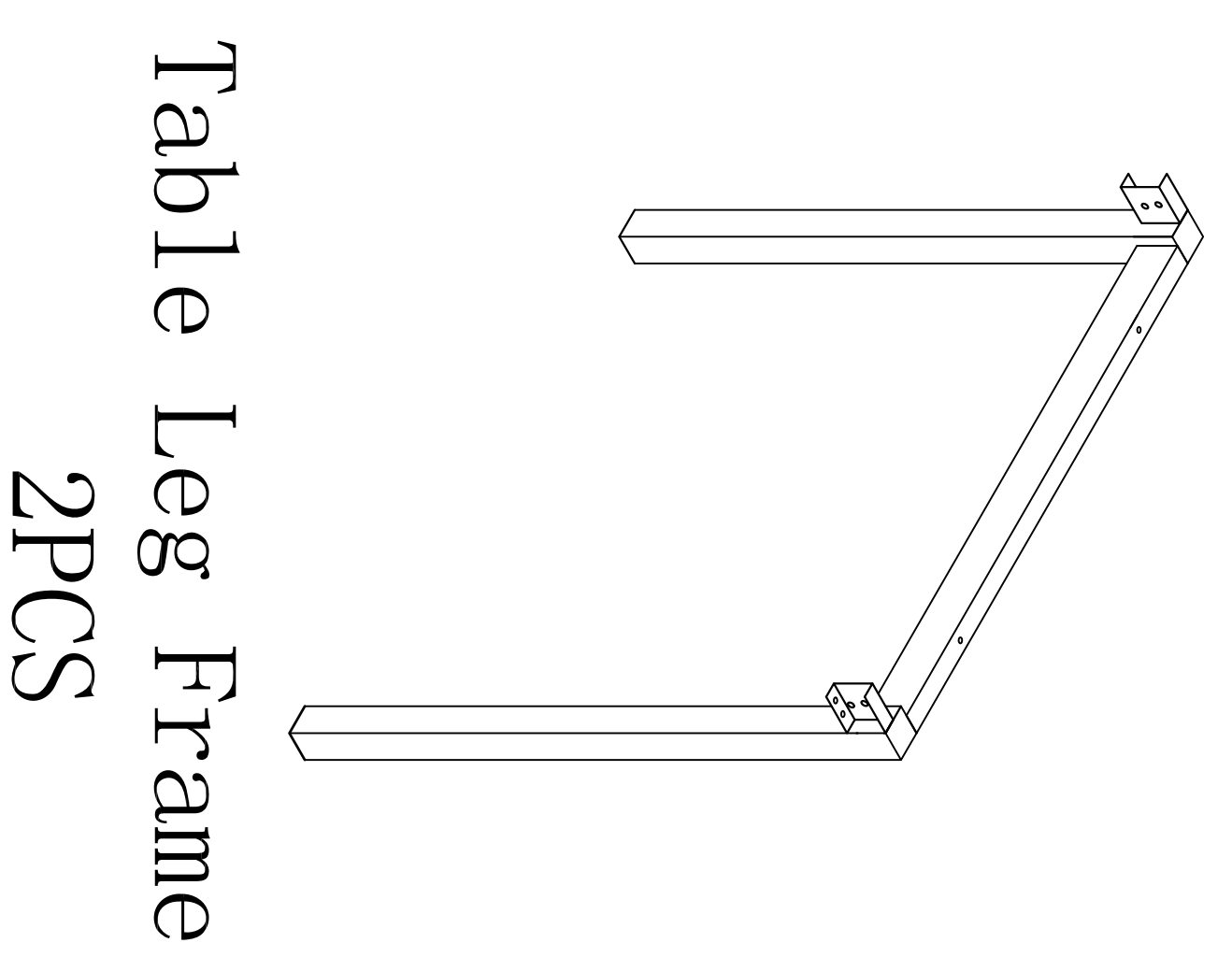

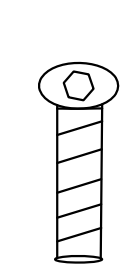
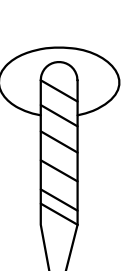
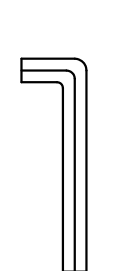
HARDWARE LIST				
A		Bolt	1/4"*16mm	16pcs
B		Screw	5mm*70mm	10pcs
C		L-Allen Key	4mm	1pc

STEP 1

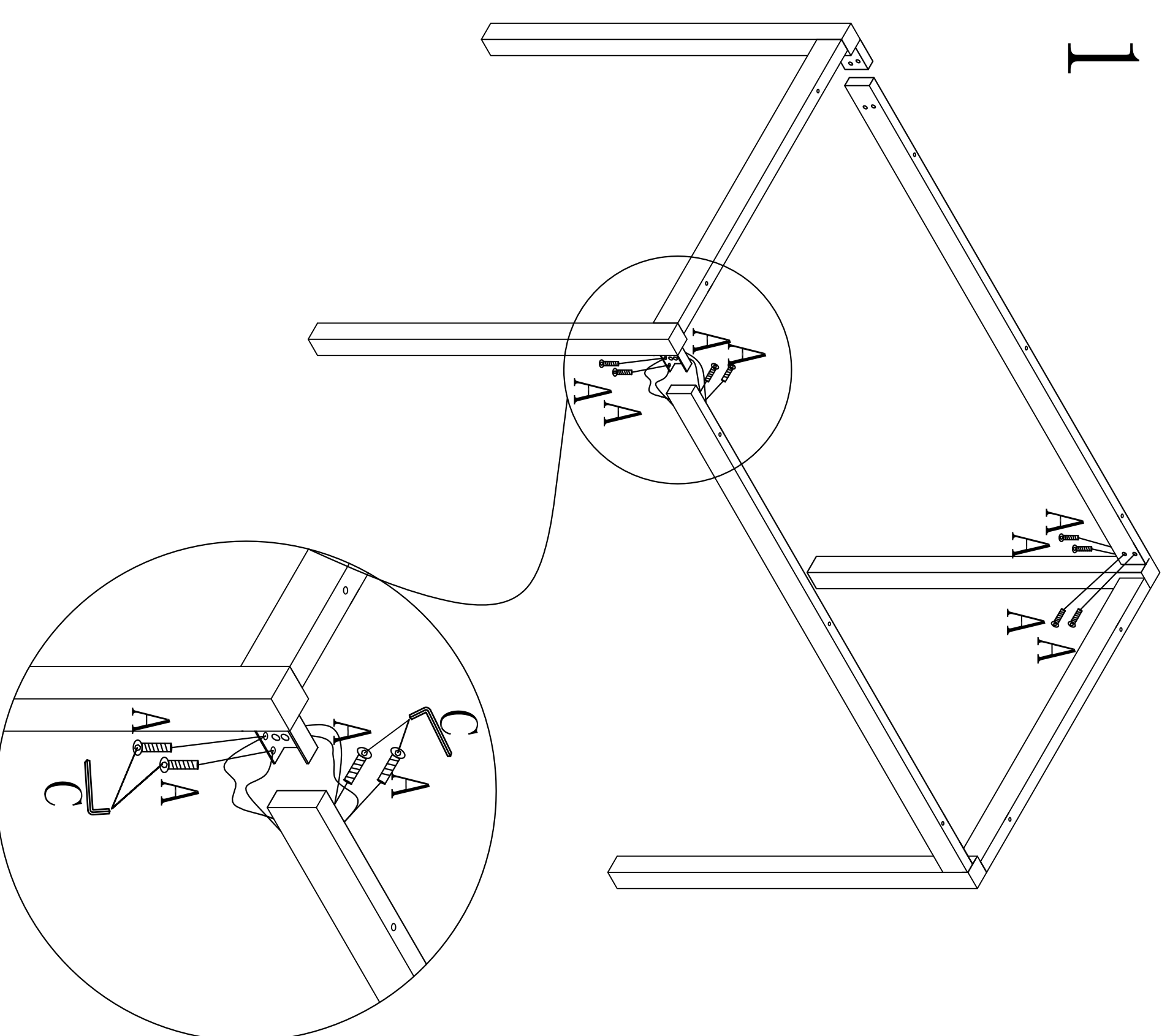

STEP 2

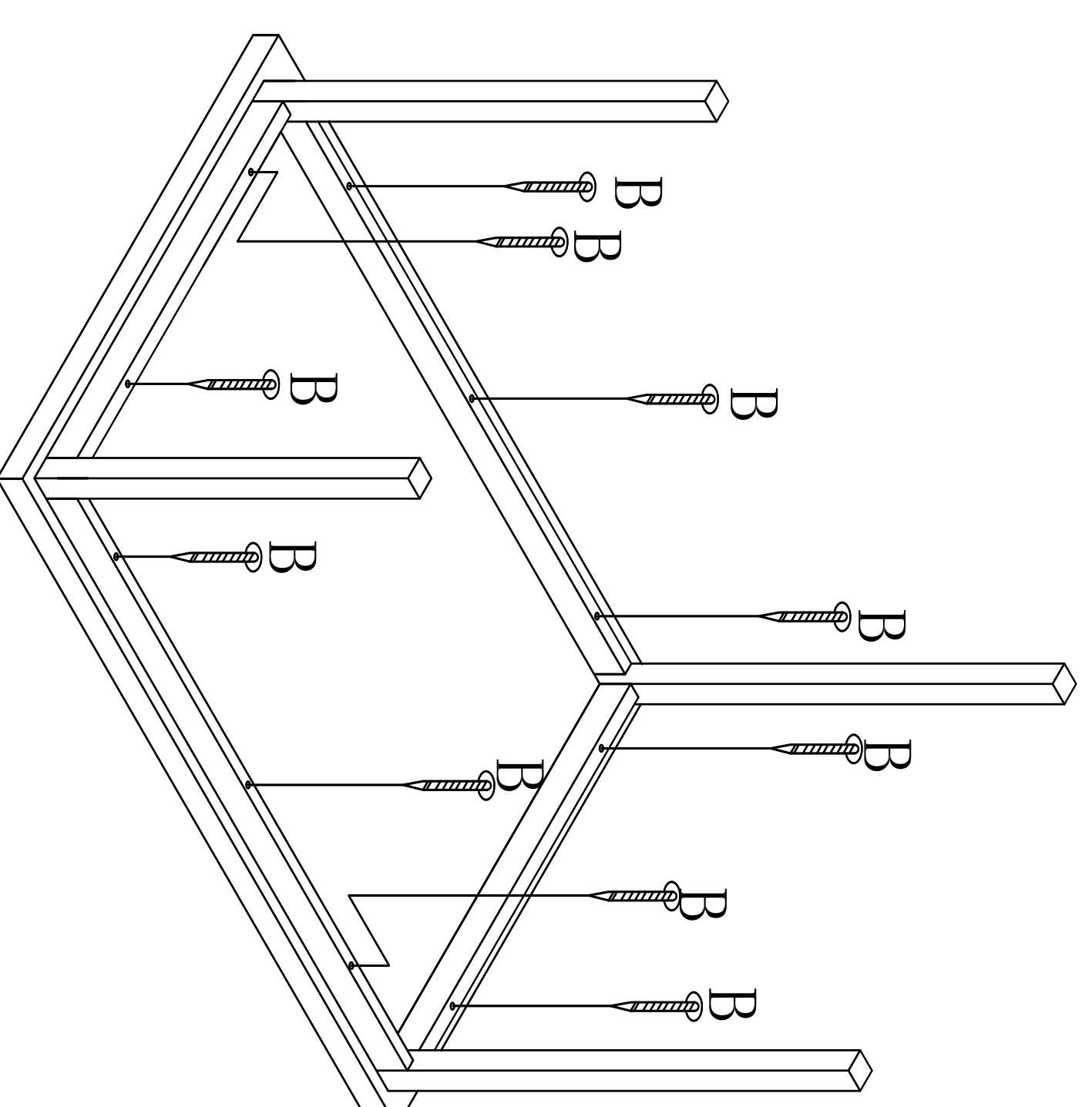

COMPLETED

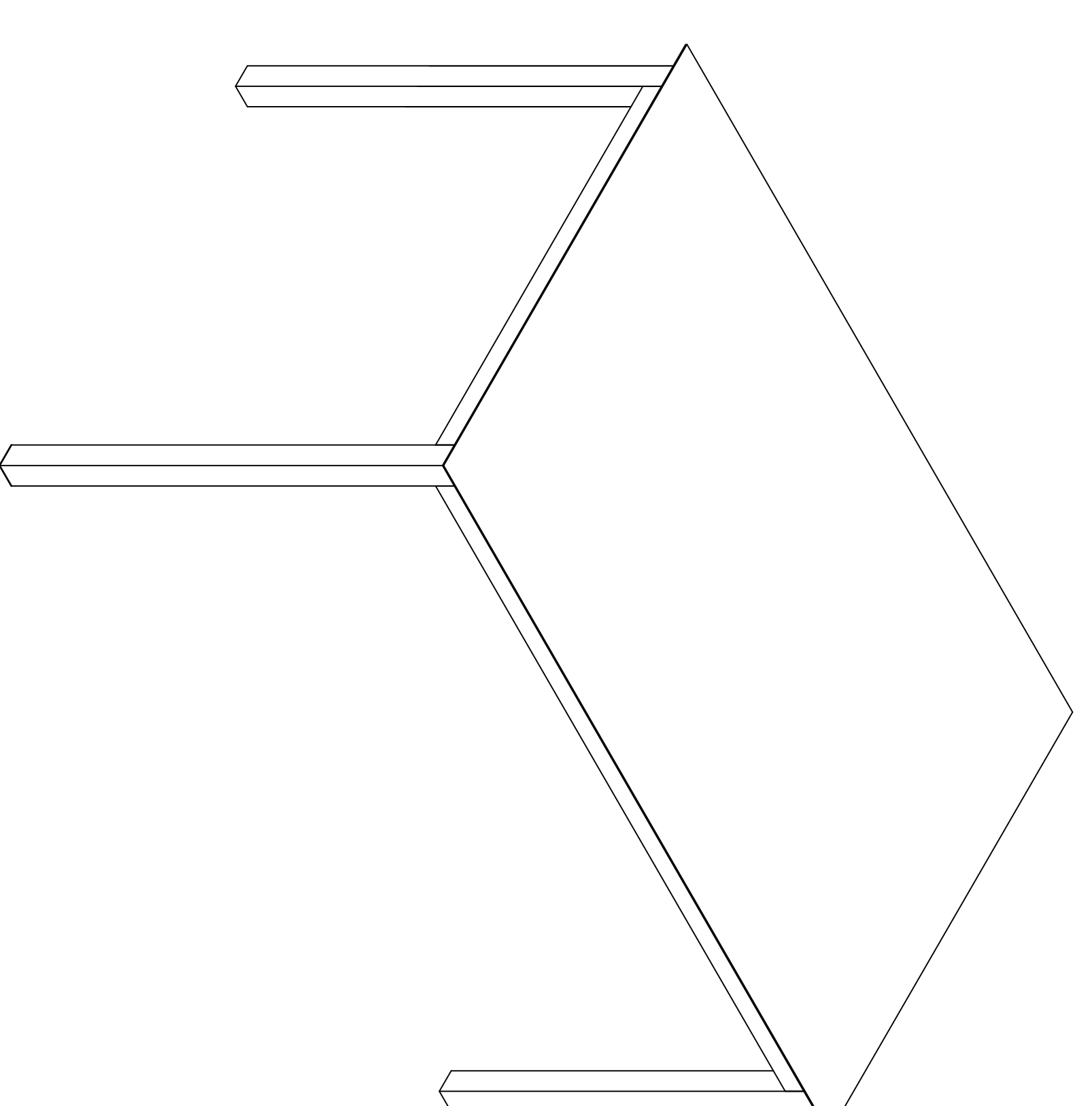

- (1) Align the table leg frame to apron and tighten with bolts.
- (2) Place the table top on the smooth and stable carpeted or padded surface. Tighten the apron to table top with screws.

! For items use on wooden floor, hard surfaces or carpets, it is recommended to install protective pads under all legs and supports to avoid/prevent from damages/scratches and discoloration.