

ASSEMBLY INSTRUCTION

2601-24 (3A) COUNTER HEIGHT STOOL

PART LIST:



Chair Frame L&R
8PCS

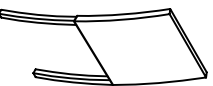

Chair Back
4PCS

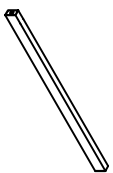



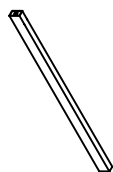

Front Top Stretcher
4PCS

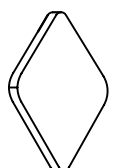

Front Bottom Stretcher
4PCS



Seat Cushion
4PCS

HARDWARE LIST				
A		Long Bolt	1/4"*38mm	16pcs
B		Long Bolt	1/4"*19mm	16pcs
C		Long Bolt	1/4"*43mm	8pcs
D		Screw	5mm*56mm	16pcs
E		L-Allen Key	4mm	1pc

STEP 1

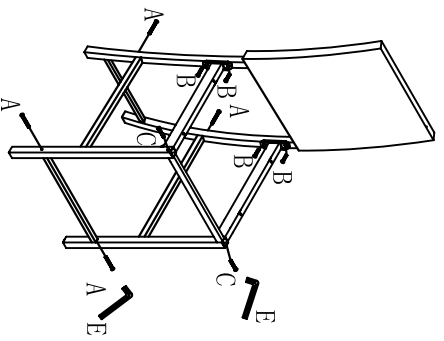

STEP 2

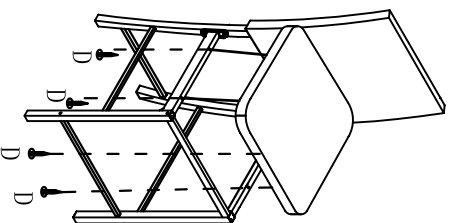

COMPLETED

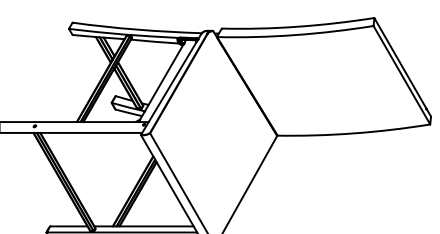

- (1) Align the chair frame L&R to the chair back and front rail, insert the bolt to the holes and tighten it.
- (2) Attach the seat cushion to the seat, insert the screw then tighten it.