

ASSEMBLY INSTRUCTION

2544-13 BENCH

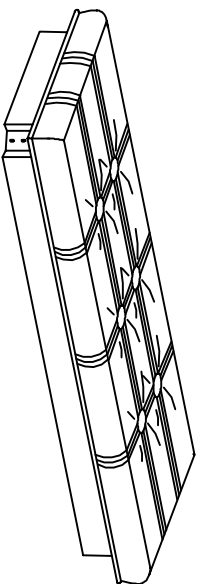

PART LIST:

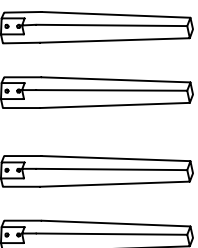

Bench top
1pc

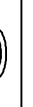

Bench leg
4pcs

HARDWARE LIST				
A		L-ALLEN KEY	12mm	1 PC
B		Bolt	Ø5/16"x2-1/2"	8 PCS
C		Spring Washer	Ø5/16"	8 PCS
D		Flat Washer	Ø5/16"xØ23mm	8 PCS

STEP 1

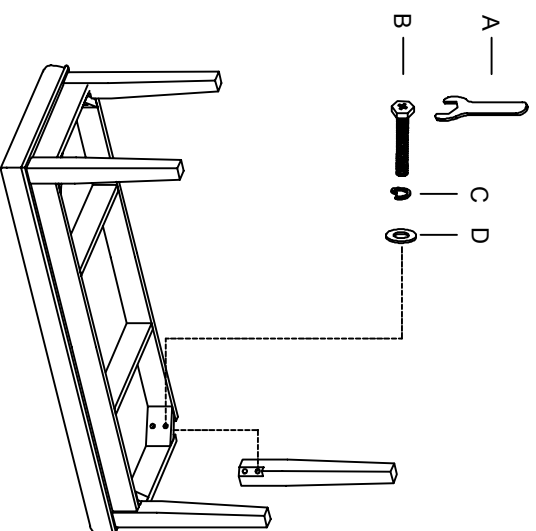

(1) Align the bench leg to the pre-drilled holes, tighten with bolt and washer.

COMPLETED

