











Thank you for purchasing this product. Please take time to read and follow the instructions below. Check that you have all parts and hardware before assembly. Parts apparently missing are often found in the packing materials. If you do not have all the parts listed, have your dealer contact us and they will be sent to you immediately.

Merci d'avoir acheté ce produit de qualité. Vérifiez avant le montage que vous avez toutes les pièces et fixations. Les pièces qui semblent manquer se trouvent souvent dans les matériaux d'emballage. Si vous n'avez pas toutes les pièces de la liste, demandez à votre détaillant et nous les enverrons immédiatement.

HARDWARE LIST/ LISTE DE QUINCAILLERIE			PARTS LIST/ LISTE DE PIECES			
1		Allen Key/ Cle Allen(L57mm x 4m/m)	1	A	 Chair Back/ Dossier de chaise	1
2		Bolt / Boulon 5/16"x1-1/2"	2	B	 Cushion seat with frame/ Encadrement de siège avec siège coussiné	1
3		Bolt / Boulon 5/16"x2-1/4"	4			
4		Bolt / Boulon 5/16"x3-1/4"	4	C	 Front leg(L/R)/ Pieds avant	2
5		Lock Washer / Rondelle d'arrêt (5/16"x13mm x 1.2mmT)	10			
6		Flat Washer / Rondelle plate (5/16"x19mm x 1.8mmT)	10			

 For items use on wooden floor, hard surfaces or carpets, it is recommended to install protective pads under all legs and supports to avoid/prevent from damages/scratches and discoloration.

 Pour les articles utilisés sur un plancher en bois, des surfaces dures ou tapis, il est recommandé d'installer des mordaches de protection sous tous les jambes et prend en charge pour éviter/empêcher de dommages/raures et la décoloration.

STEP 1/ ETAPE 1

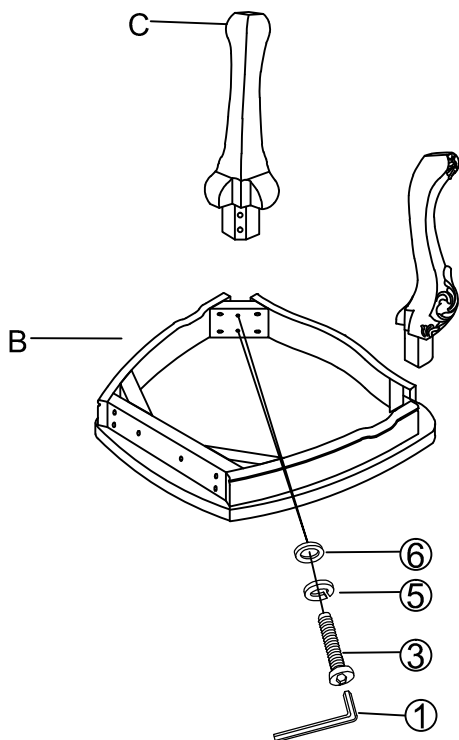

STEP 2/ ETAPE 2

