

ASSEMBLY INSTRUCTION INSTRUCTIONS DE MONTAGE

1711-4



NIGHT STAND / TABLE DE NUIT





Thank you for purchasing this product. Please take time to read and follow the instructions below. Check that you have all parts and hardware before assembly. Parts apparently missing are often found in the packing materials. If you do not have all the parts listed, have your dealer contact us and they will be sent to you immediately.

 It is recommended to install protective pads under all legs and supports to avoid damage or scratches when placing furniture on a wood floor or other hard surface, and to limit indentation and prevent discoloration if placing on carpet.

Merci d'avoir acheté ce produit de qualité. Vérifiez avant le montage que vous avez toutes les pièces et fixations. Les pièces qui semblent manquer se trouvent souvent dans les matériaux d'emballage. Si vous n'avez pas toutes les pièces de la liste, demandez à votre détaillant et nous vous les enverrons immédiatement.

 Il est recommandé de placer des coussins protecteurs sous tous les pieds et toutes les bases des meubles pour éviter d'endommager ou d'égratigner les planchers en bois ou autres surfaces dures, et pour limiter l'empreinte et empêcher la décoloration quand les meubles reposent sur la moquette.

PART LISTS / LISTE DE PIÈCES			
NO.	DESCRIPTION	SKETCH	Q'TY
A	Night Stand / Table De Nuit		1PC
B	Leg/ Peid		4PCS

HARDWARE LIST/ LISTE DE QUICAILLERIE				
NO.	DESCRIPTION	SKETCH	Dimension	Q'TY
1	Bolt / Boulon		$\Phi 1/4" * 2"$	8pcs
2	Spring Washer / Rondelle D'arret		$\Phi 1/4" * \Phi 10 * \frac{5}{64}"$	8pcs
3	Flat Washer / Rondelle Plate		$\Phi 1/4" * \Phi 19 * \frac{5}{16}"$	8pcs
4	Allen Wrench / Cle Allen		$2 \frac{21}{64} * \frac{5}{32}"$	1pc

*ABOVE HARDWARE ARE PACKED IN #1711-4 FOR ASSEMBLY

Step 1/ Etape 1

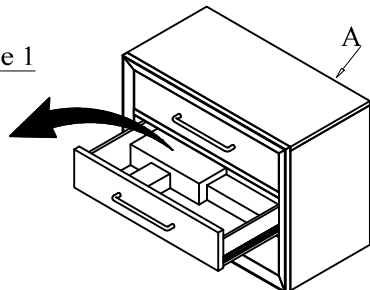

**LEGS ARE INSIDE THE BOTTOM DRAWER /
PIED DANS LE TIOIR INFERIEUR**

Step 2/ Etape 2

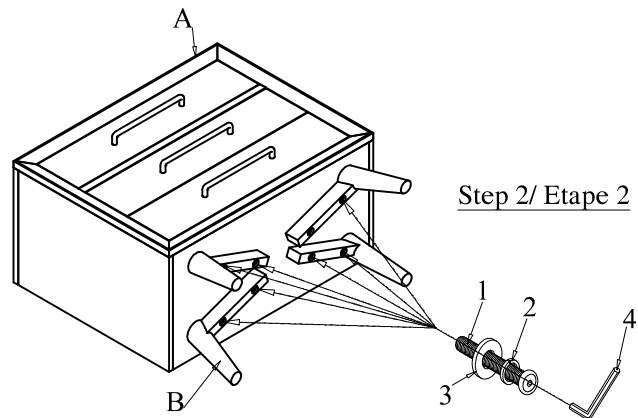

COMPLETED

MADE IN VIETNAM / FABRIQUER EN VIETNAM