

Attention:
Two people are required for assembly and lifting unit.

ASSEMBLY INSTRUCTION

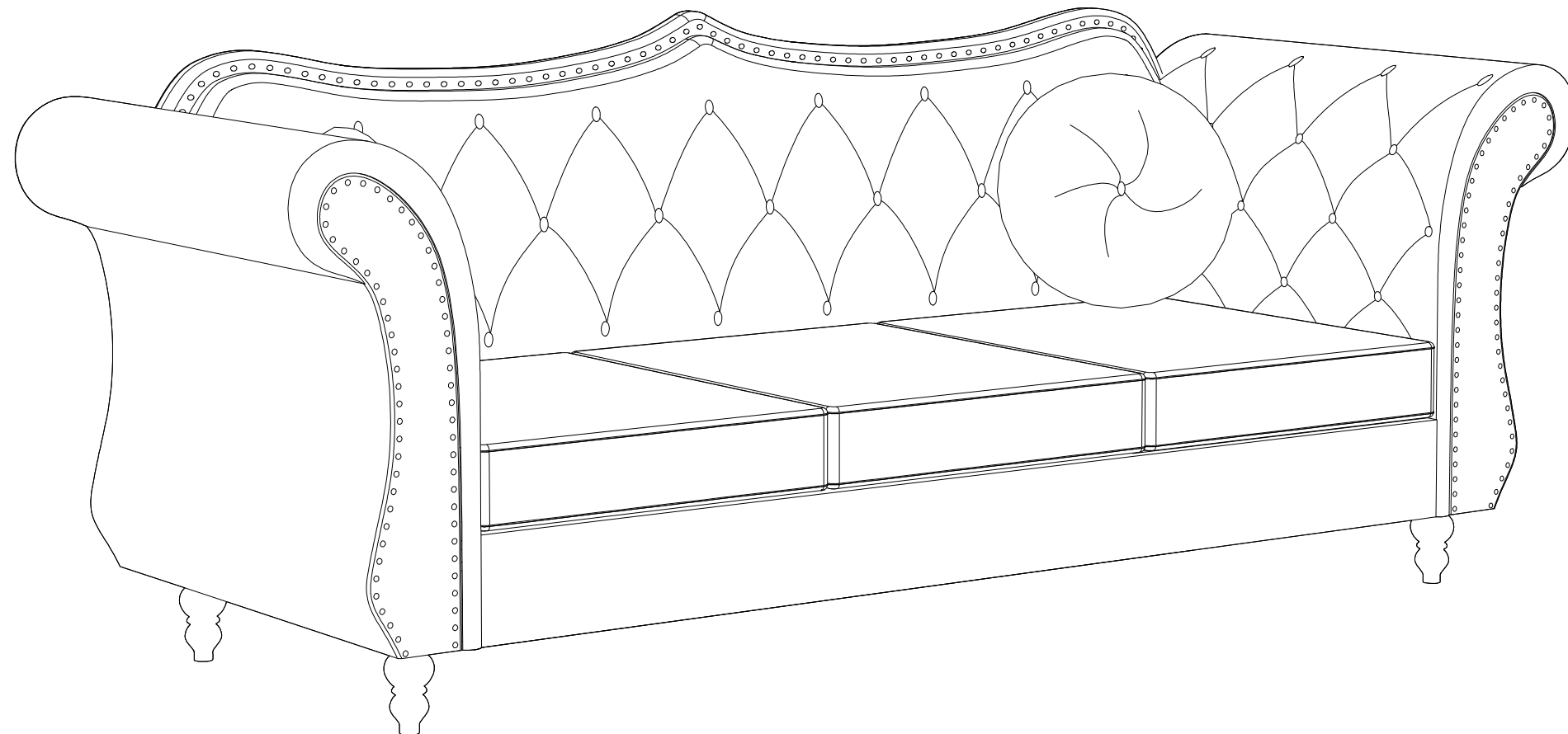

ASSEMBLY PARTS

1.

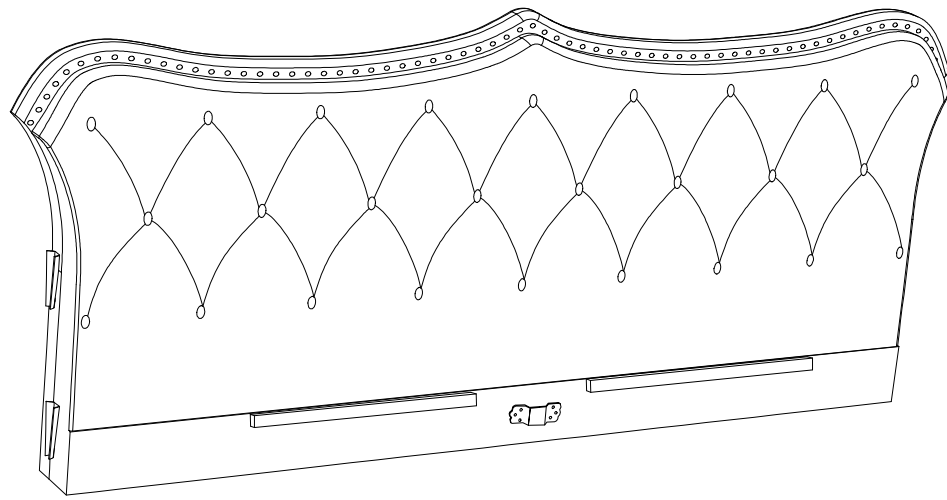

BACK REST (1PC)

2.

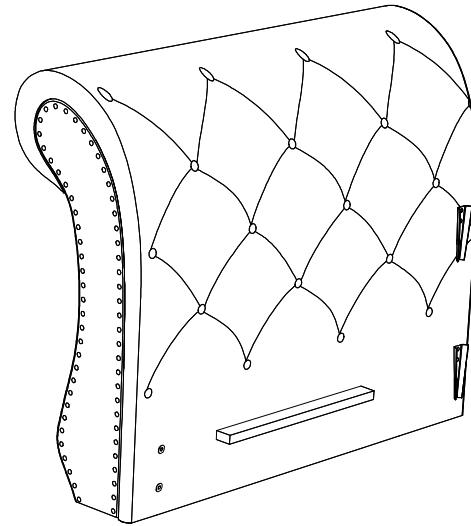

LEFT ARM (L) (1PC)

3.

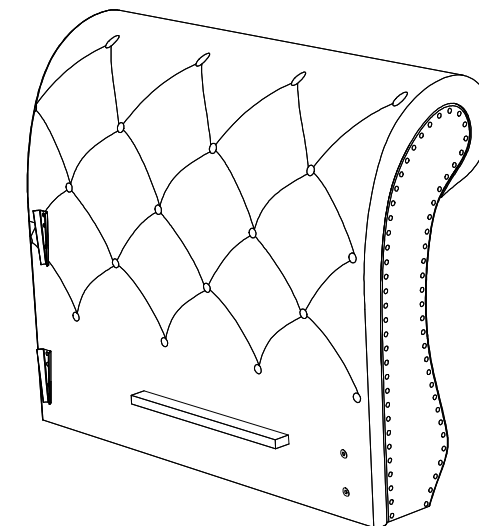

RIGHT ARM (R) (1PC)

4.

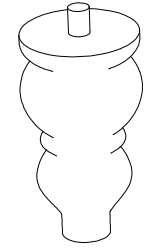

LEG (4PCS)

5.

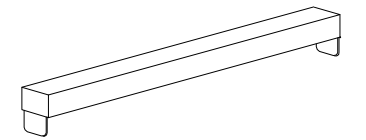

SEAT PANEL SUPPORT (1PC)

6.

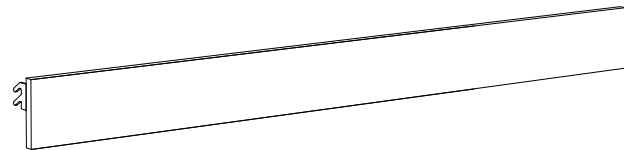

FRONT RAIL (1PC)

7.

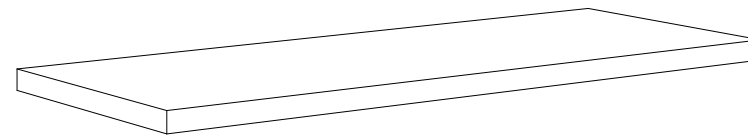

SEAT PANEL (1PC)

8.

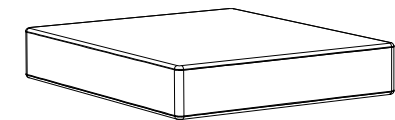

SEAT CUSHION (3PCS)

9.

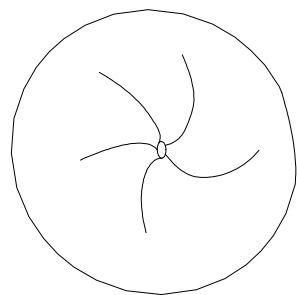

PILLOW (2PCS)



A

1PC

Allen Key M4

1 : 1



ASSEMBLY INSTRUCTION

STEP 1.
For this step remove all the part.

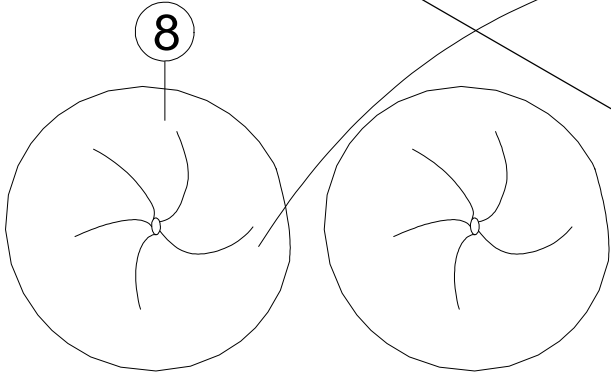
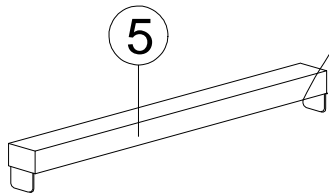
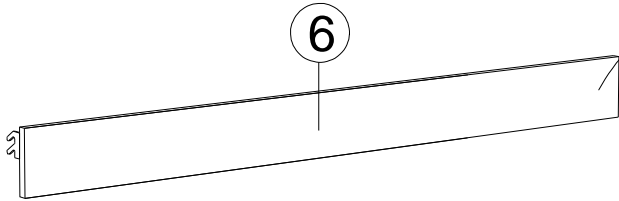
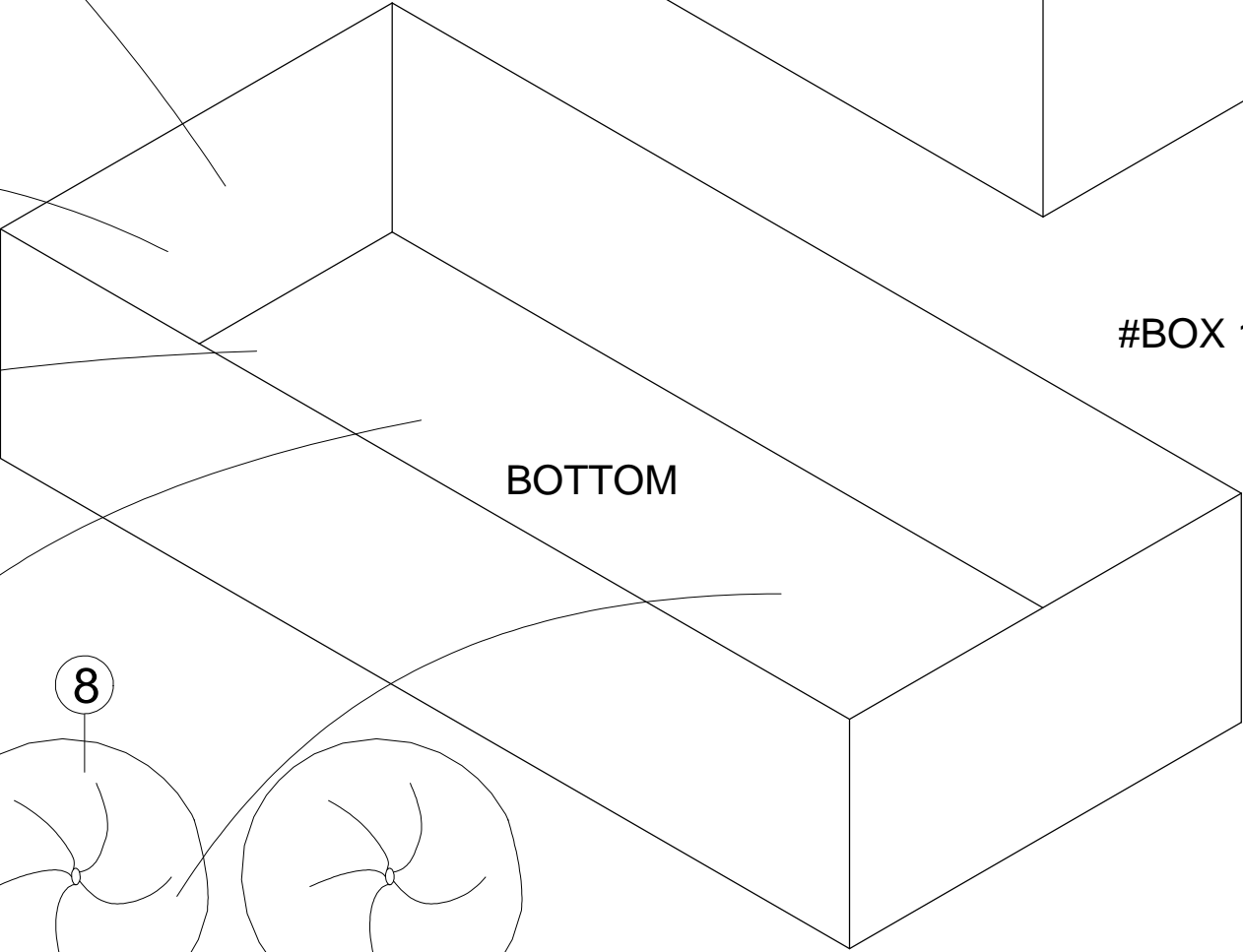
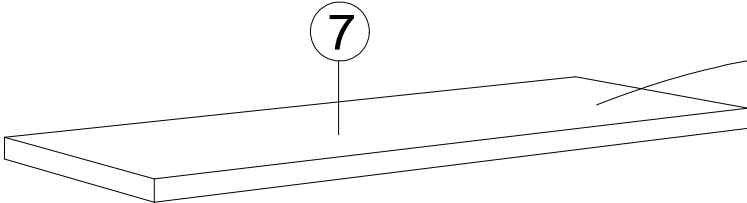
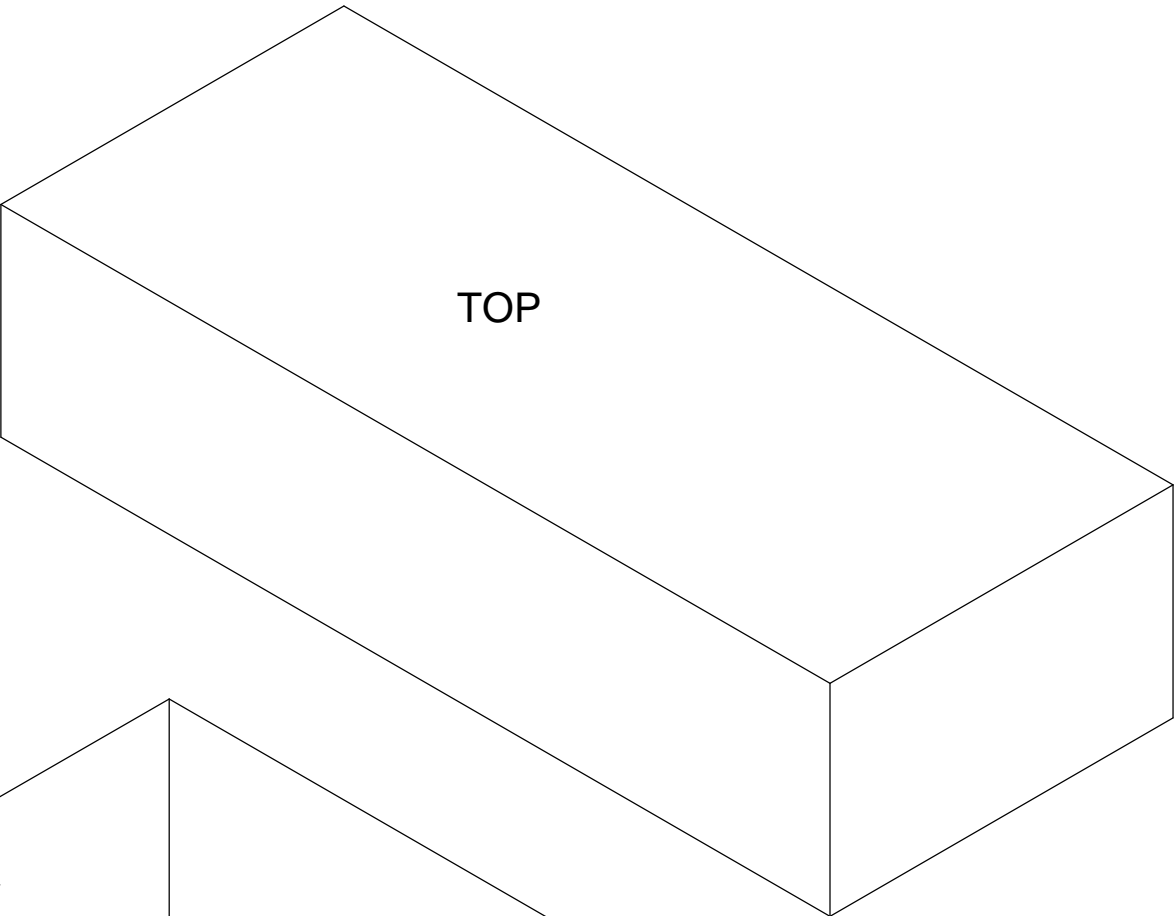
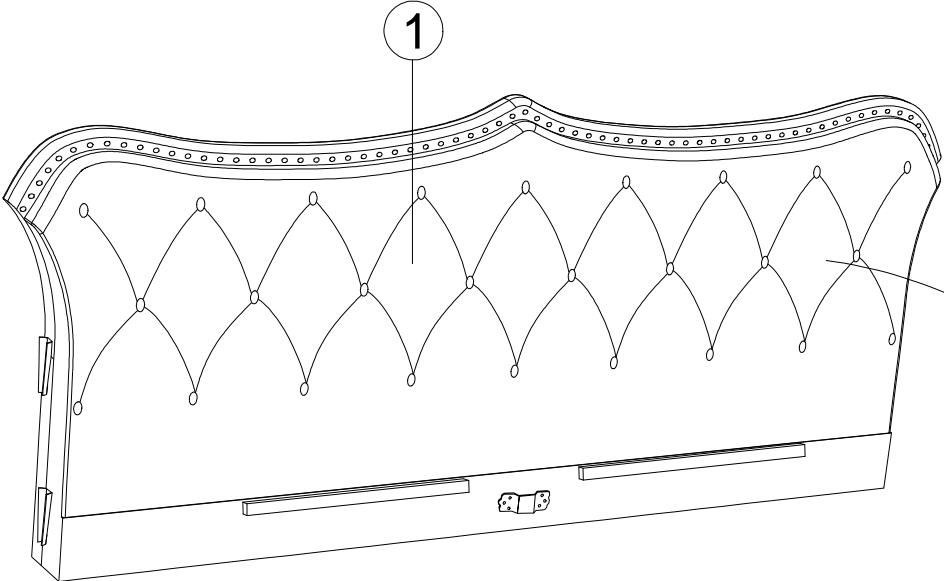

2X

ASSEMBLY INSTRUCTION

STEP 2.
For this step remove all the part.

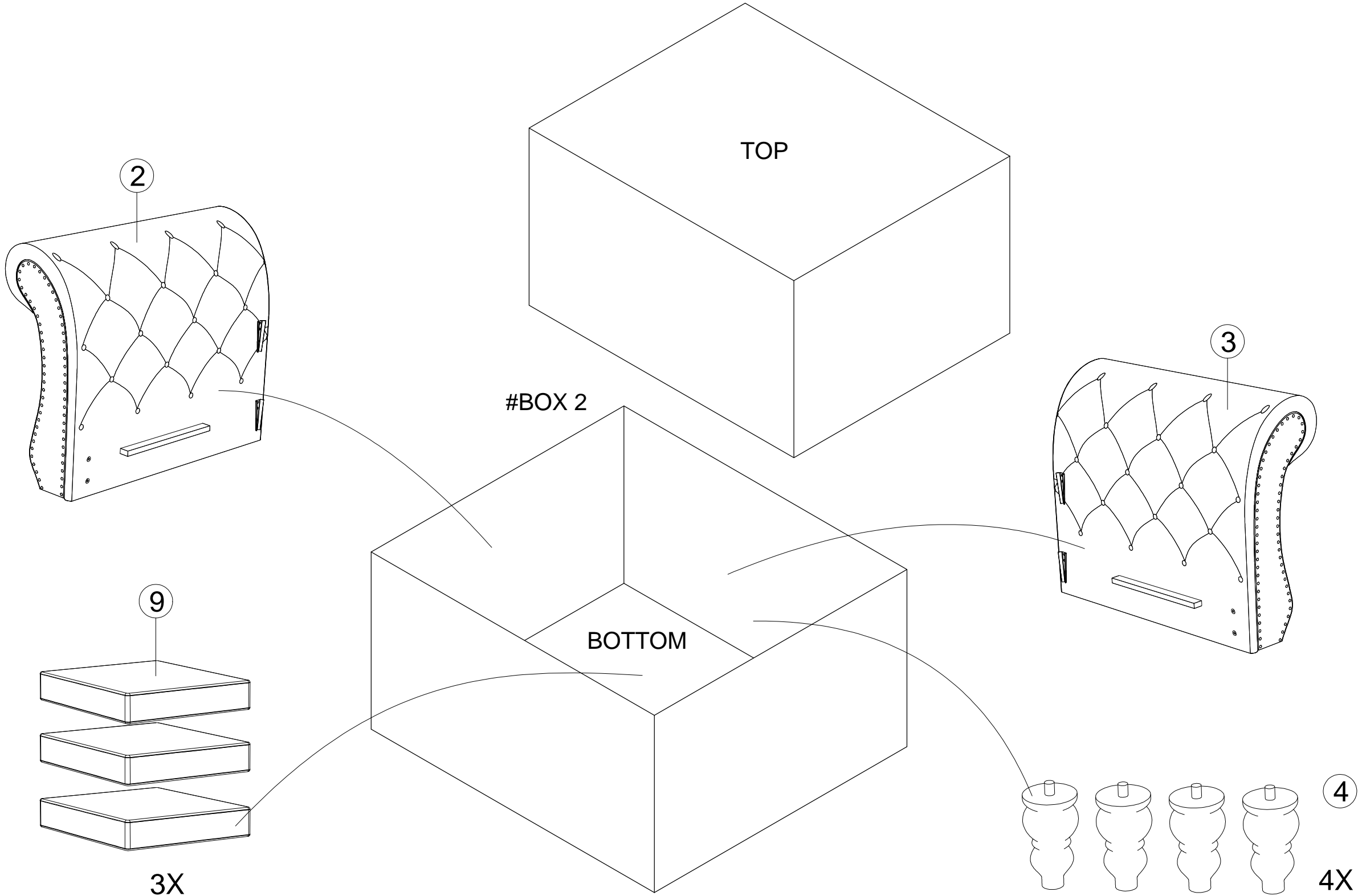

ASSEMBLY INSTRUCTION

STEP 3.

Attach Leg (4) (4pcs) to the Left Arm (2) and Right Arm (3)

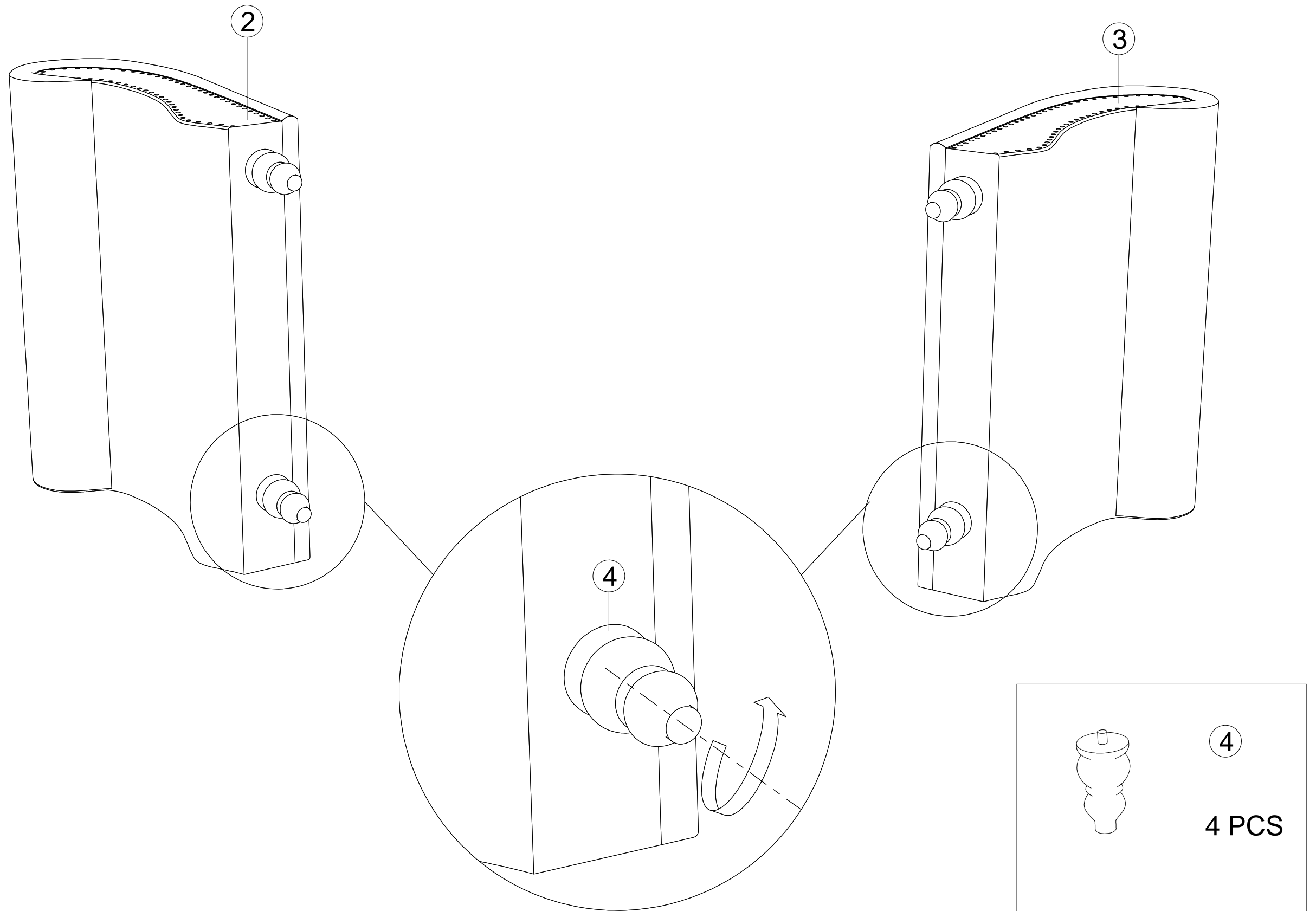

ASSEMBLY INSTRUCTION

STEP 4.

Hook on the Back Rest (1) into Left Arm (2) and Right Arm (3) securely.

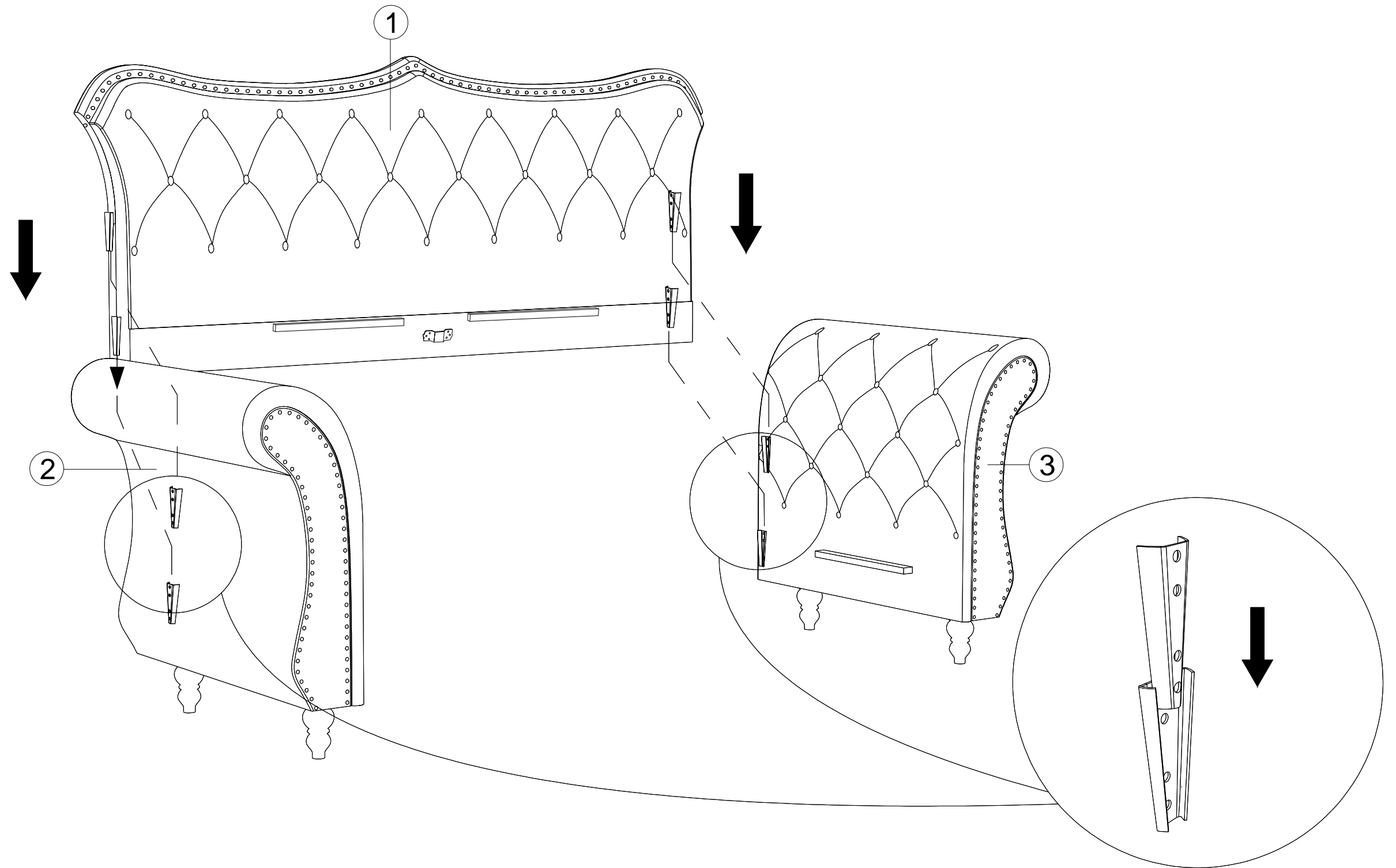

ASSEMBLY INSTRUCTION

STEP 5.

Slightly loosen the four bolts using Allen Key (A) without removing the bolts completely from both Side Arms

(2 and 3). Hook on Front Rail (6) hooks into loosen bolts, once placed tighten and secure all four bolt with Allen Key (A).

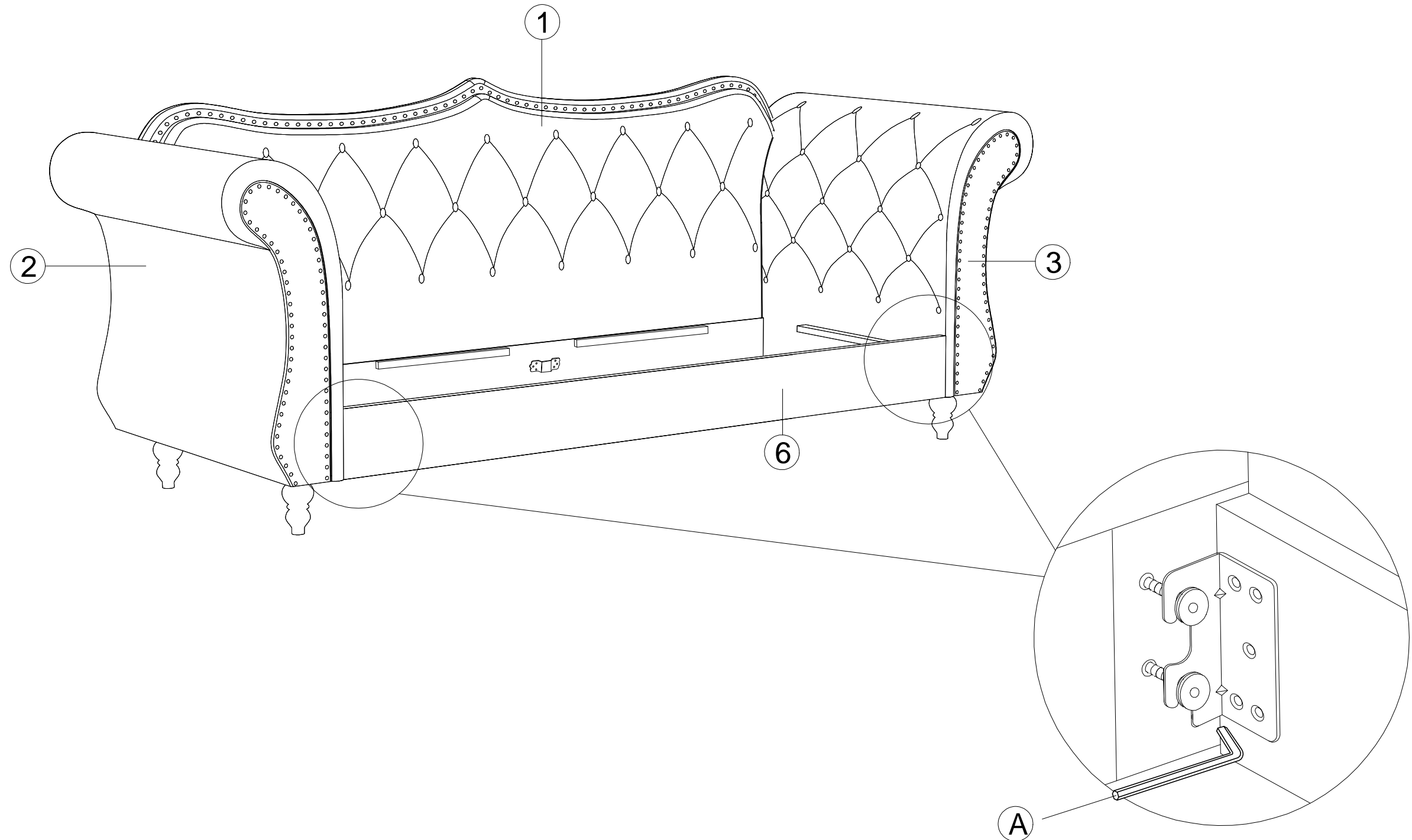

ASSEMBLY INSTRUCTION

STEP 6.

Hook on and secure Seat Panel Support (5) to the two metal slots on both Front Rail (6) and Back Rest (1).

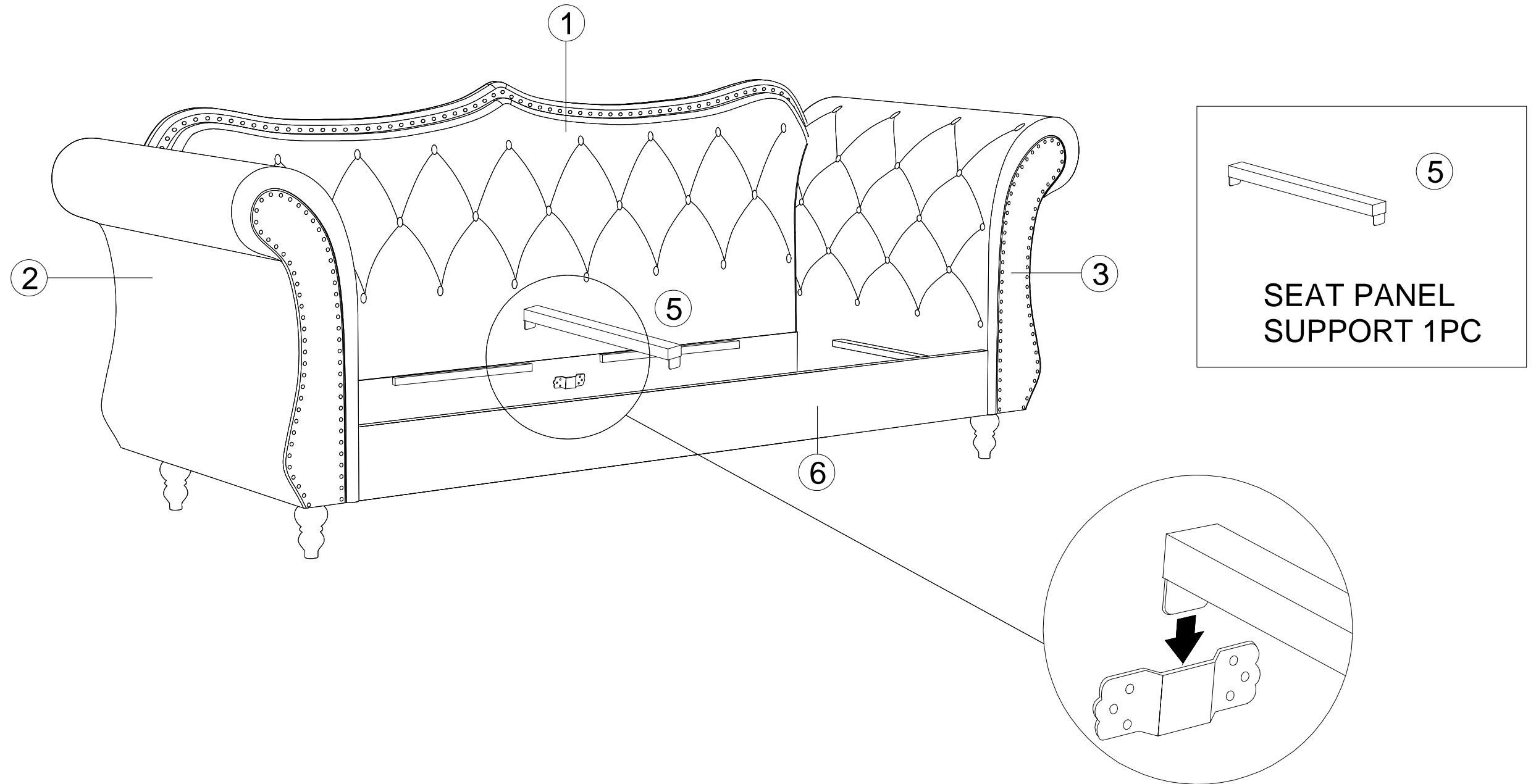

ASSEMBLY INSTRUCTION

STEP 7.

Lay the Seat Panel (7) on top of units frame.

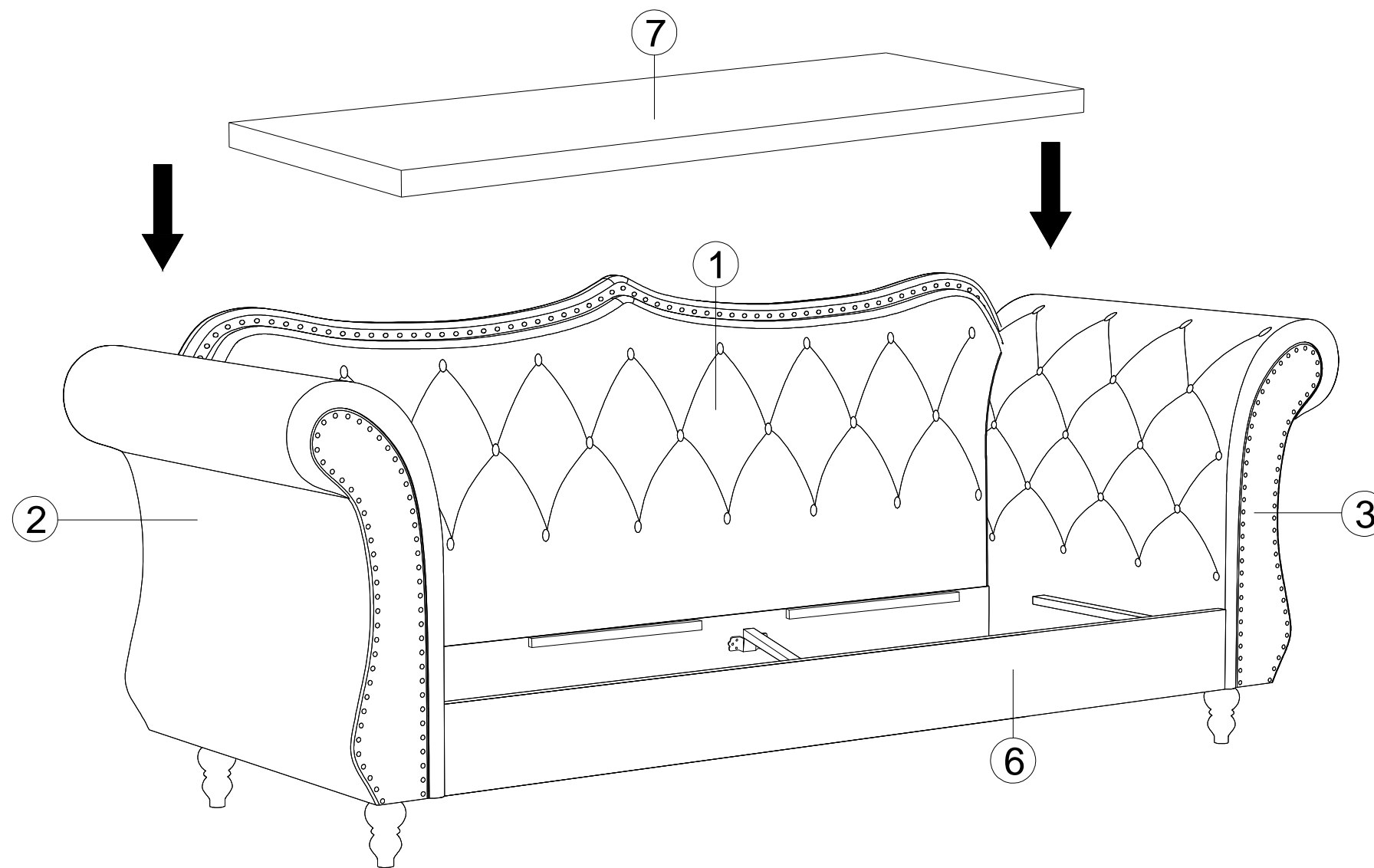

ASSEMBLY INSTRUCTION

STEP 8.

Lay the Seat Panel (7) on top of units frame.

