



ASSEMBLY INSTRUCTION

MODEL NO: JORDYN - WHITE / GREY - MR





DESCRIPTION: MIRROR

Thank you for purchasing this quality product. Be sure to check all packing material carefully for small parts that may have come loose inside the carton during shipment.

PART LIST :

ITEM	DRAWING	DESCRIPTION	QTY
A		MIRROR	1
B		MIRROR SUPPORT	1
C		MIRROR SUPPORT	1

HARDWARE LIST :

ITEM	DRAWING	DESCRIPTION	QTY
D		JCBC SCREW (M6 x 35mm)	8
E		SPRING WASHER (M8)	8
F		FLAT WASHER (M8 x 18mm)	8
G		ALLEN KEY (M4 x 65mm)	1

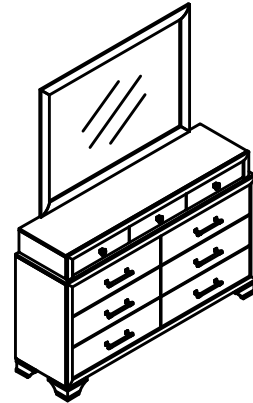

COMPLETED MIRROR

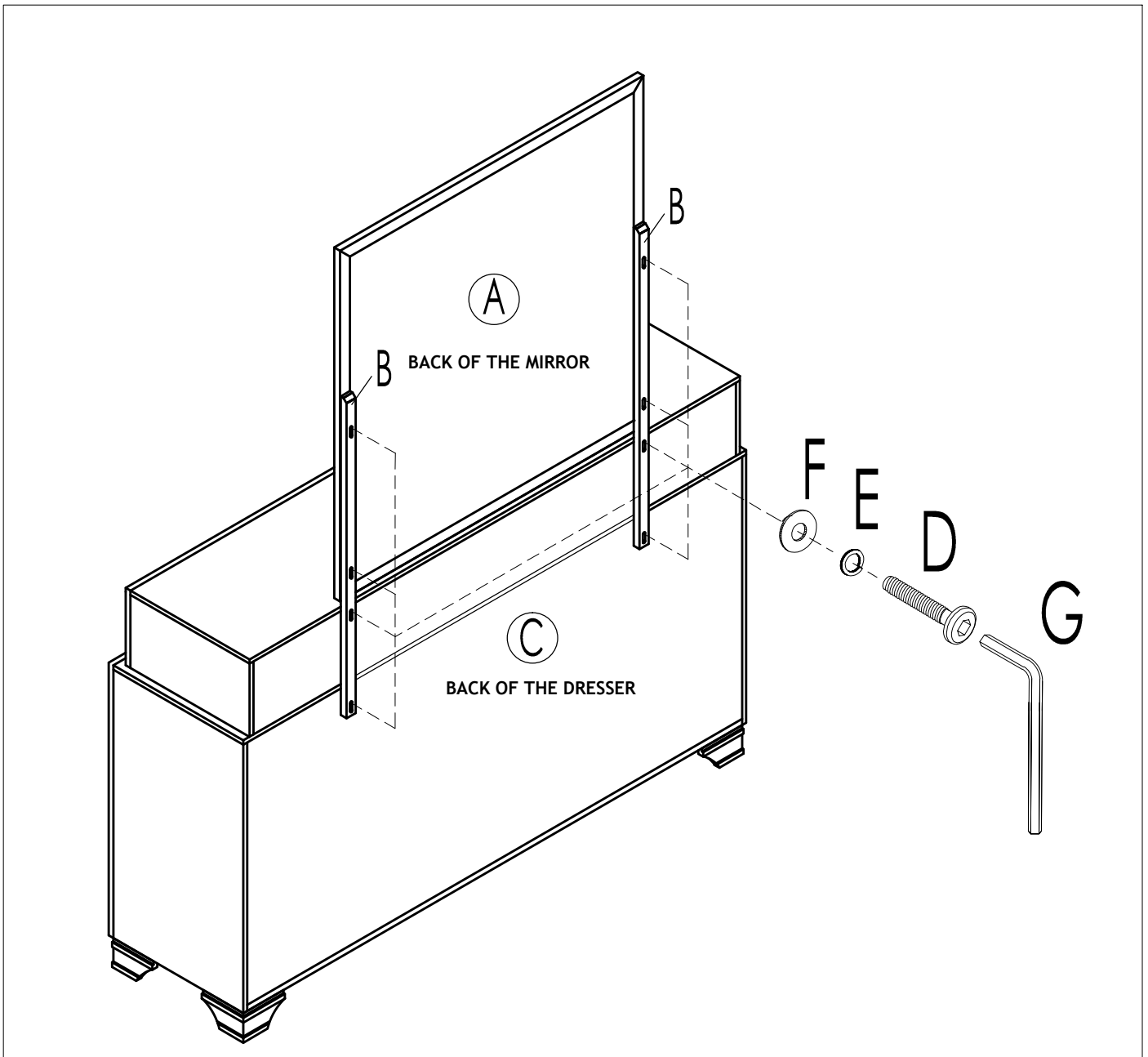

NOTE : MUST TIGHTEN SCREWS PERIODICALLY. WITH USE SCREW MAY BECOME LOOSE. CHECK TIGHTNESS OF ALL SCREWS EVERY 6-8 WEEKS.

CLEANING INSTRUCTION :
AFTER ASSEMBLE, CLEAN & POLISH THE COMPLETED PARTS IF NECESSARY WITH SOFT CLOTH AND INDUSTRIAL RECOGNIZED FURNITURE POLISH.

MADE IN MALAYSIA