



Furniture of America®

E-Commerce by Enitial Lab

# ASSEMBLY INSTRUCTIONS

MODEL #

CM7734EK/CK

Questions?

GIVE US CALL: 1-888-980-5122  
MON-FRI 8:30AM - 5:30PM (PST)

## TOOLS REQUIRED



Allen Wrench

(Included)



Phillips  
Screwdriver

(Not Included)

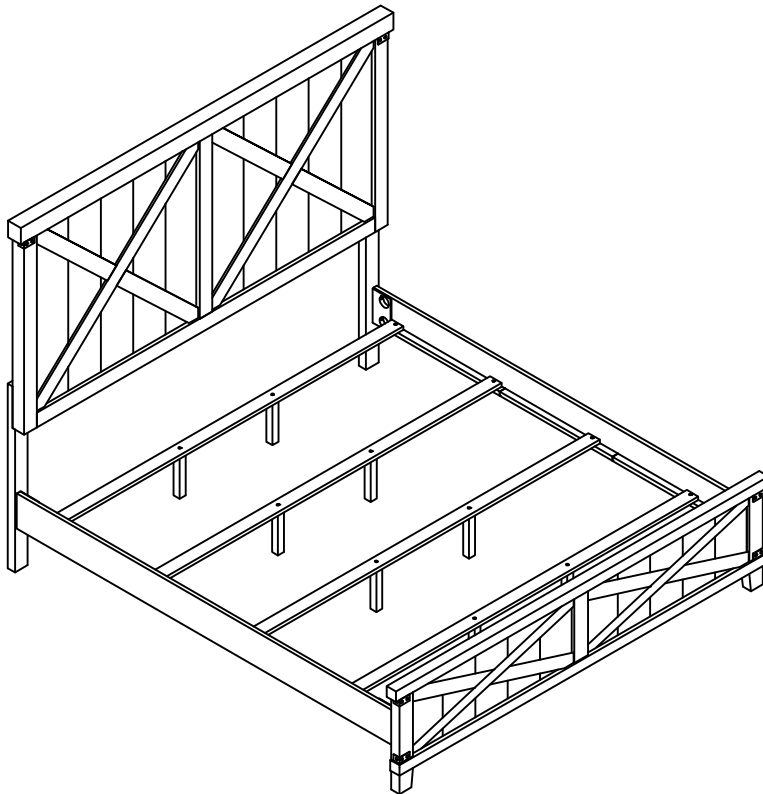

2 - People  
Recommended

## ASSEMBLY RATING



EASY ————— DIFFICULT

The Assembly Rating is a 5-point system showing the level of effort needed to assemble a specific product.



FOA Intro

Thank you for your purchase!

We hope you enjoy this new addition to your home for many years to come.

Our commitment to providing quality products does not simply end when you purchase our product. We fully stand behind our products from start to finish. Our customer service department is available Monday – Friday 8:30 AM – 5:30 PM Pacific and can help with assembly questions as well as, if necessary, replacing damaged or missing parts. To help expedite our service, please have these assembly instructions readily available, along with your order receipt.

 **Consumer Hotline**  
Toll-Free 1-888-980-5122

 **WEBSITE**  
[www.foagroup.com](http://www.foagroup.com)

    foagroup

 **Monday to Friday**  
8:30AM- 5:30PM (PST)

 **E-MAIL**  
[cs.ec@foagroup.com](mailto:cs.ec@foagroup.com)

 FurnitureOfAmerica

---

## CHECK BEFORE STARTING

**Are you missing anything?**

Double-check all parts, hardware and accessories listed on Page 6 are accounted for.

**Should we send any replacements?**

Are there any irregularities or flaws in the parts? We can send replacements!

**Check out our Quick Tips!**

We recommend reviewing the pre-assembly handouts. Even experts need a refresher now and then!

**Prep Time!**

Please review the assembly instructions and all diagrams prior to assembling. Arrange parts as recommended on Page 7 and group identical hardware together to make assembling easier.

# PRE ASSEMBLY INTRODUCTION

We understand building ready-to-assemble furniture can be a challenging experience for some. To help avoid confusion, we have provided some helpful tips that may speed up the process.

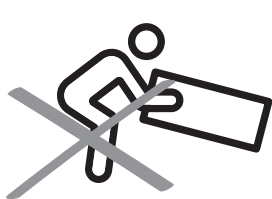

## Teamwork

ALWAYS have at least two people to help with transporting and assembling the product to avoid potential injury and/or damage.

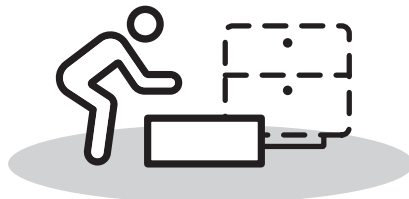
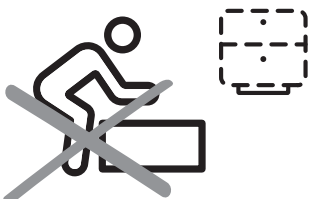

## Suitable Location

Assembling near the area of the intended location is highly recommended.



## Sufficient Space

Make sure you have enough space to move around during the assembly.

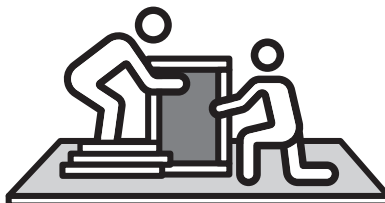

## Avoid Scratches

Use cardboard, blankets or a carpeted area while assembling furniture to prevent scratches.

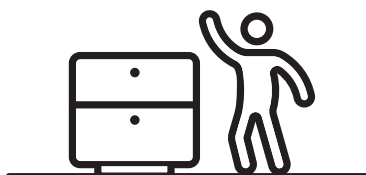
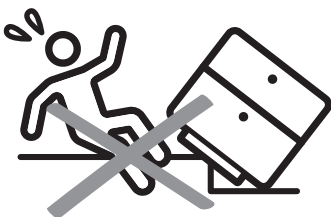

## Flat Surface

Make sure the furniture rests on a flat and level surface with each leg evenly touching the floor.

# ASSEMBLY AND CARE ADVICE



**FAILURE TO FOLLOW THE GUIDELINES BELOW MAY RESULT IN INJURY AND/OR PROPERTY DAMAGE.**



Position each part correctly and insert screws or bolts into their respective holes.

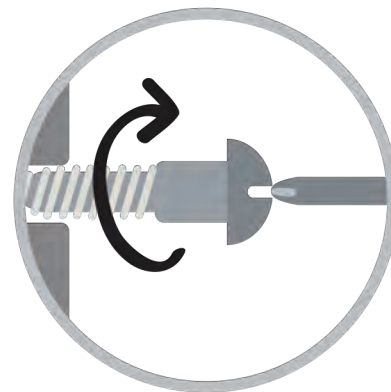

Turn clockwise to tighten and only tighten when step is completed or when instructed to do so.



Use the appropriate hand tools or power tools for assembly. Select steps, such as tightening screws and/or bolts, may require hand tools to avoid causing damage during assembly.



Save the instructions and store any supplied tools for later maintenance.

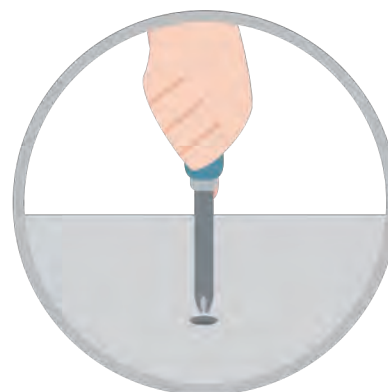

After two weeks, check and tighten any loose hardware and repeat again every six months thereafter.

**IT IS THE USER'S RESPONSIBILITY TO MAINTAIN THE FURNITURE. THE HARDWARE MAY LOOSEN OVER TIME AND MAY CAUSE THE FURNITURE TO BE WOBBLY AND UNABLE TO SUPPORT ITS INTENDED WEIGHT CAPACITY. THIS MAY LEAD TO COLLAPSE AND MAY CAUSE SERIOUS INJURY.**

# CAL.KING BED E.KING BED

CM7734EK/CK

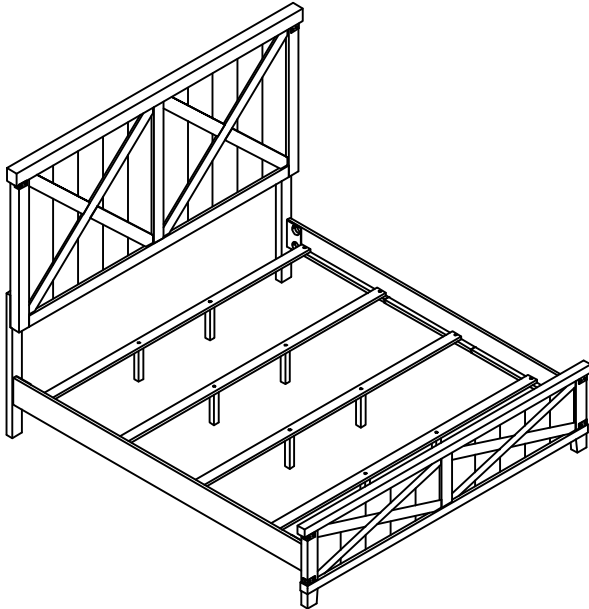
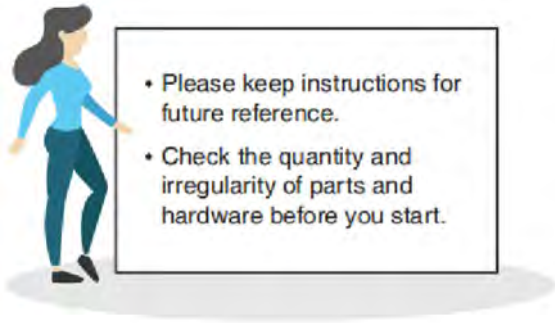

## PARTS

#1 1pc

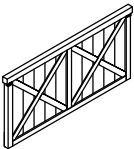

Headboard

#2 2pcs

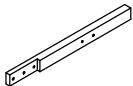

Headboard Leg  
(L & R)

#3 2pcs

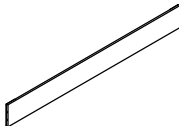

Bed Rail

#4 1pc

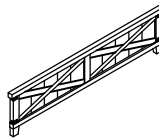

Footboard

#5 4pcs

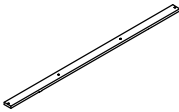

Bed Slat

#6 8pcs

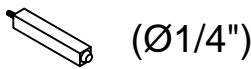

Support Leg  
254x30x30mm

## HARDWARE

#A 6pcs



Bolt  $\text{\O}5/16'' \times 2-1/4''$

#B 6pcs



Lock Washer  
 $\text{\O}5/16''$

#C 6pcs



Flat Washer  
 $\text{\O}5/16''$

#D 1pc

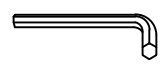

Allen Wrench 4mm

#E 8pcs

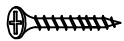

Wood Screw  
 $\#4 \times 1-1/4''$

#F 8pcs

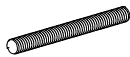

Thread Bolt  
 $\text{\O}5/16'' \times 4''$

#G 8pcs



Hex Nut  
 $\text{\O}5/16'' \times 7/8''$



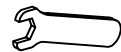



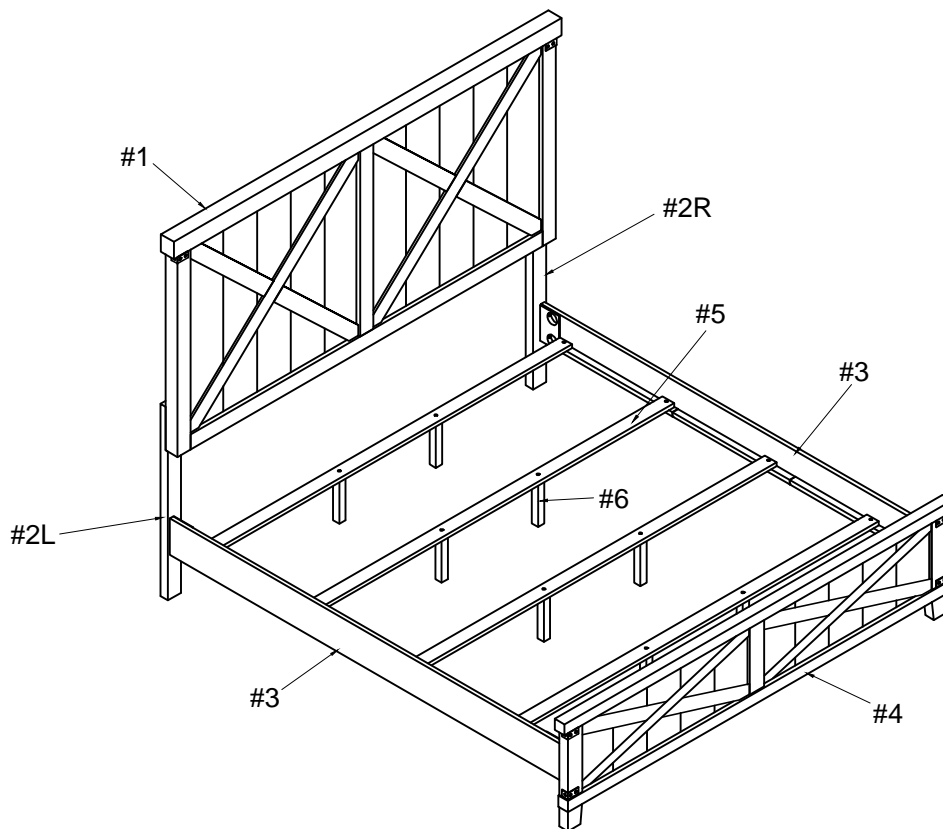

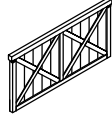

#H 1pc

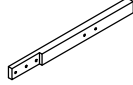

Wrench  
12mm

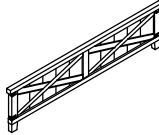
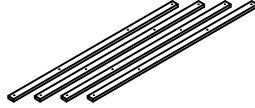
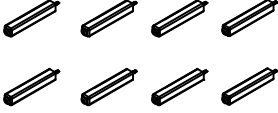
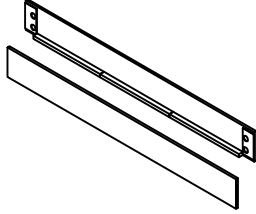

## CM7734EK&CK is packed in 3 cases

Carton	Disignation	Part		Hardware
CM7734Q-HB	Headboard	#1		 #A x 6pcs  #B x 6pcs  #C x 6pcs
	HB Legs ( L & R)	#2		 #D x 1pc
CM7734Q-FB	Footboard	#4		
	Bed Slat (4pcs)	#5		
	Support Leg (8pcs)	#6		
CM7734Q-R	Side Rail	#3		 #E x 6pcs  #F x 8pcs  #G x 8pcs  #H x 1pc

# ASSEMBLY INSTRUCTIONS

## 1

- Part #1 x1pc
- Part #2 x1pc
- Hardware #A x6pcs
- Hardware #B x6pcs
- Hardware #C x6pcs

Align HB legs (#2R/L) to the headboard (#1), then secure by using bolts (#A) with washers (#B,C).

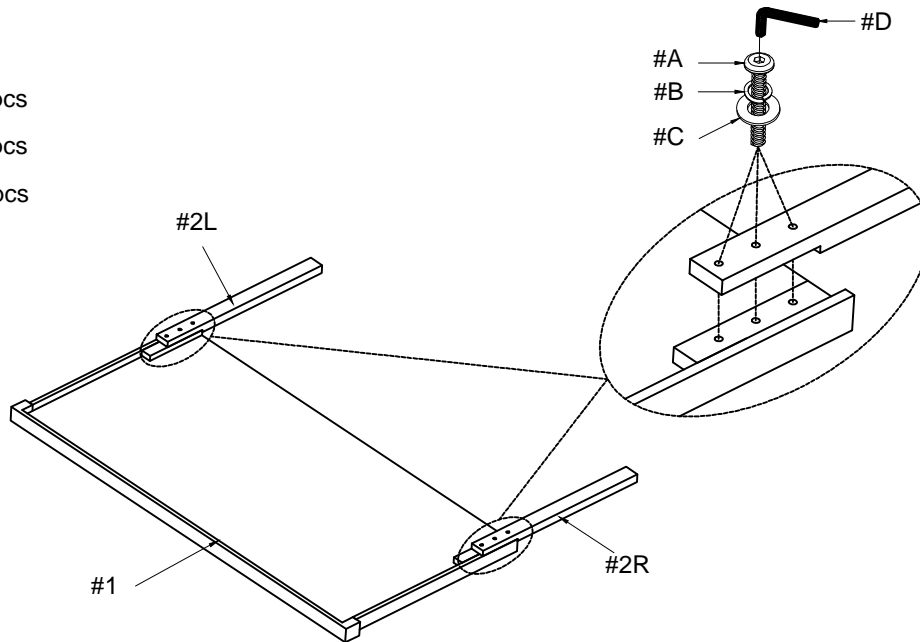

## 2

- Part #3 x2pcs
- Part #4 x1pc
- Hardware #F x8pcs
- Hardware #G x8pcs

Attach threaded studs (#F) to the headboard and footboard (#4), then align side rails (#3) to the studs (#F). Secure by using hex nuts (#G).

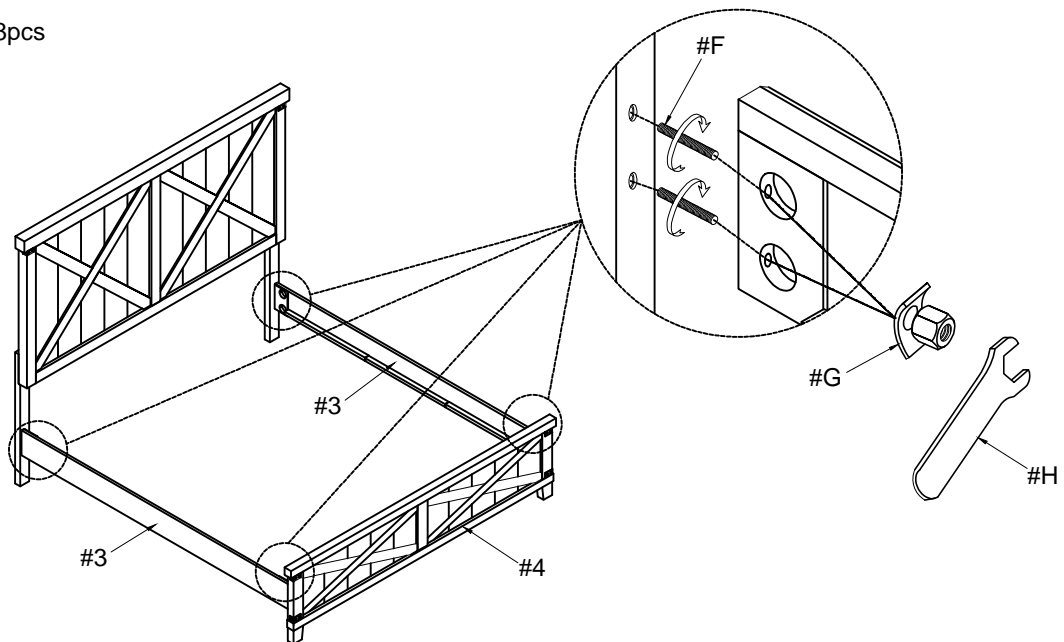



# ASSEMBLY INSTRUCTIONS

## 3

Part #5 x1pc  
Part #6 x2pcs

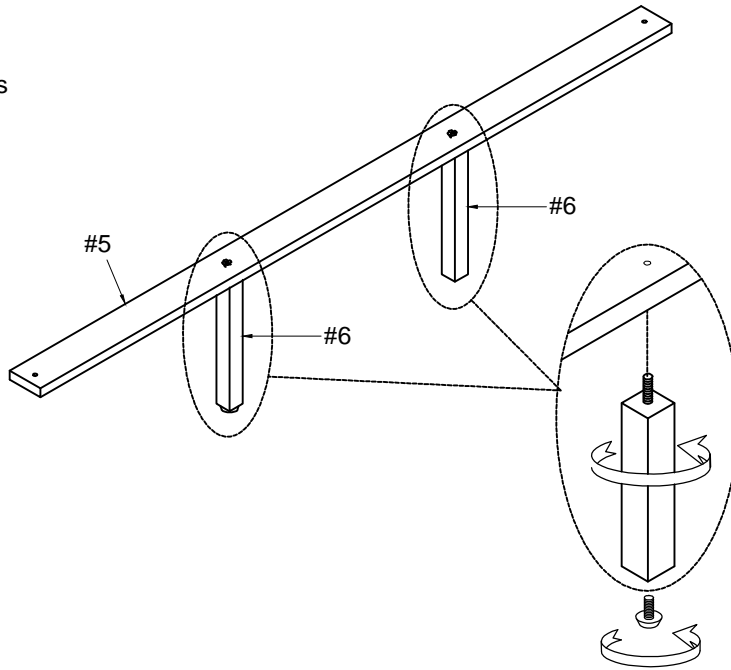

Attach support legs (#6) to the slats (#5).

x4

## 4

Hardware #E x8pcs

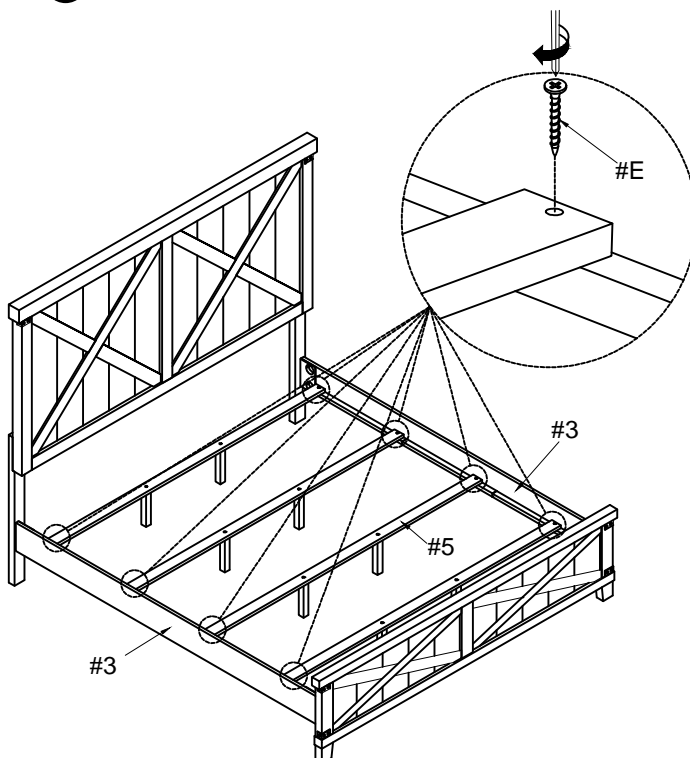

Align slats (#5) to the side rails (#3), then secure by using screws (#E).

## ASSEMBLY COMPLETED



Please ensure the furniture rests on an even and flat surface. If the product wobbles or feels loose, double-check all bolts and/or screws are properly tightened and secured.



### Keep this handy!

Please retain this instruction manual and any order-related information for future reference.



### Lift, don't drag!

To avoid damage to product please always LIFT the product when transporting or adjusting the placement.