



Furniture of America[®]

E-Commerce by Enitial Lab

ASSEMBLY INSTRUCTIONS

MODEL #

CM7584EK

Questions?

GIVE US A CALL: 1-888-980-5122
MON – FRI 8:30AM – 5:30PM (PST)

TOOLS REQUIRED



Allen Wrench

(Included)



Philips Screwdriver

(Not Included)

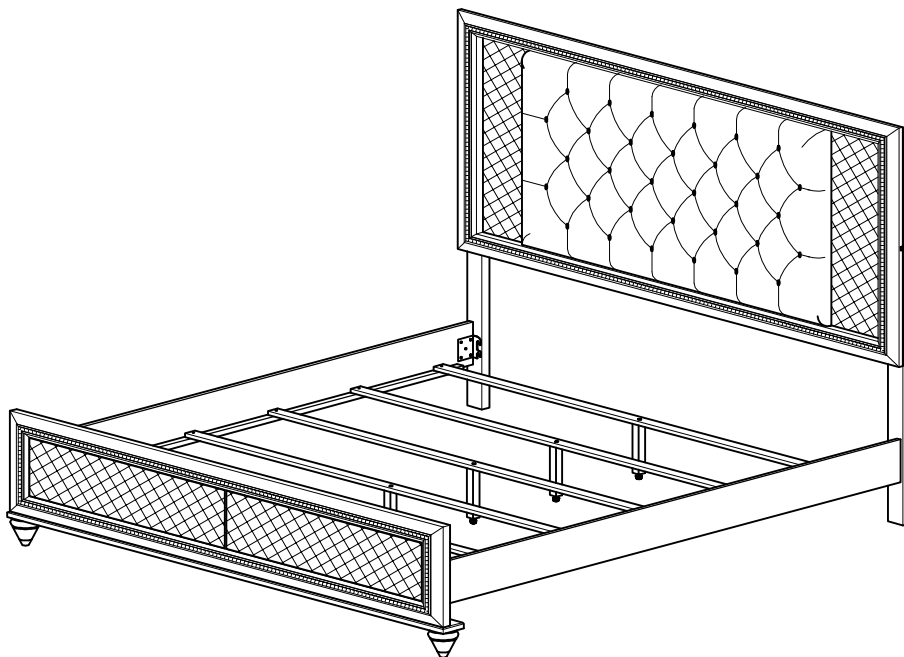

3 - People Recommended

ASSEMBLY RATING



EASY —————> DIFFICULT

The Assembly Rating is a 5-point system showing the level of effort needed to assemble a specific product.



FOA Intro

Thank you for your purchase!

We hope you enjoy this new addition to your home for many years to come.

Our commitment to providing quality products does not simply end when you purchase our product. We fully stand behind our products from start to finish. Our customer service department is available Monday – Friday 8:30 AM – 5:30 PM Pacific and can help with assembly questions as well as, if necessary, replacing damaged or missing parts. To help expedite our service, please have these assembly instructions readily available, along with your order receipt.

 **Consumer Hotline**
Toll-Free 1-888-980-5122

 **Monday to Friday**
8:30AM- 5:30PM (PST)

 **WEBSITE**
www.foagroup.com

 **E-MAIL**
cs.ec@foagroup.com

    foagroup

 FurnitureOfAmerica

CHECK BEFORE STARTING

Are you missing anything?

Double-check all parts, hardware and accessories listed on Page 6 are accounted for.

Check out our Quick Tips!

We recommend reviewing the pre-assembly handouts. Even experts need a refresher now and then!

Should we send any replacements?

Are there any irregularities or flaws in the parts? We can send replacements!

Prep Time!

Please review the assembly instructions and all diagrams prior to assembling. Arrange parts as recommended on Page 7 and group identical hardware together to make assembling easier.

PRE ASSEMBLY INTRODUCTION

We understand building ready-to-assemble furniture can be a challenging experience for some. To help avoid confusion, we have provided some helpful tips that may speed up the process.

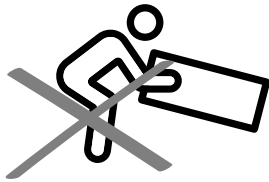

Teamwork

ALWAYS have at least two people to help with transporting and assembling the product to avoid potential injury and/or damage.

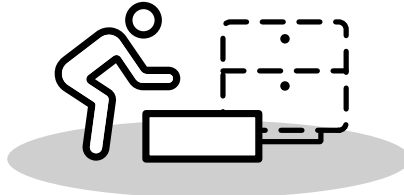
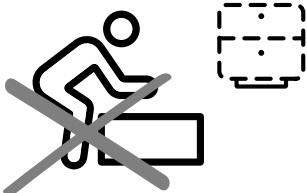

Suitable Location

Assembling near the area of the intended location is highly recommended.



Sufficient Space

Make sure you have enough space to move around during the assembly.

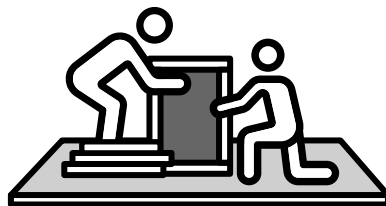

Avoid Scratches

Use cardboard, blankets or a carpeted area while assembling furniture to prevent scratches.

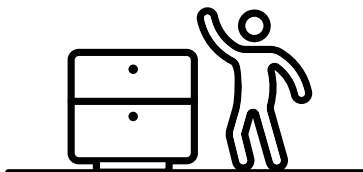
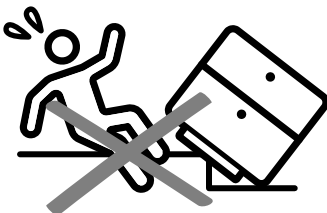

Flat Surface

Make sure the furniture rests on a flat and level surface with each leg evenly touching the floor.

ASSEMBLY AND CARE ADVICE



FAILURE TO FOLLOW THE GUIDELINES BELOW MAY RESULT IN INJURY AND/OR PROPERTY DAMAGE.



Position each part correctly and insert screws or bolts into their respective holes.



Turn clockwise to tighten and only tighten when step is completed or when instructed to do so.



Use the appropriate hand tools or power tools for assembly. Select steps, such as tightening screws and/or bolts, may require hand tools to avoid causing damage during assembly.



Save the instructions and store any supplied tools for later maintenance.



After two weeks, check and tighten any loose hardware and repeat again every six months thereafter.

IT IS THE USER'S RESPONSIBILITY TO MAINTAIN THE FURNITURE. THE HARDWARE MAY LOOSEN OVER TIME AND MAY CAUSE THE FURNITURE TO BE WOBBLY AND UNABLE TO SUPPORT ITS INTENDED WEIGHT CAPACITY. THIS MAY LEAD TO COLLAPSE AND MAY CAUSE SERIOUS INJURY.

KING BED

CM7584EK



- Please keep instructions for future reference.
- Check the quantity and irregularity of parts and hardware before you start.

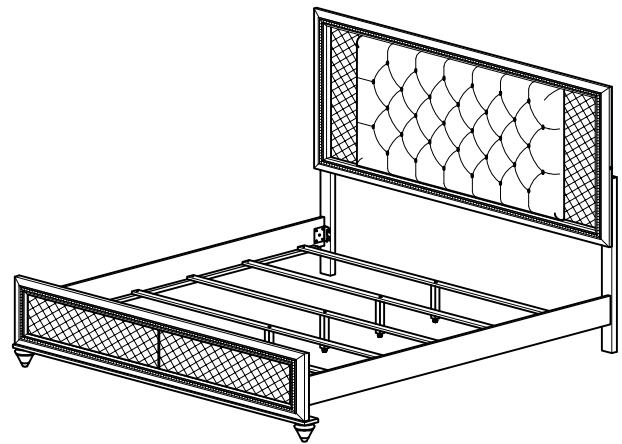

PARTS

PART LIST OF HEADBOARD

#1 1pc

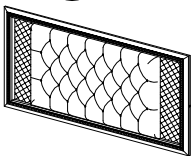

Headboard

#2 1pc

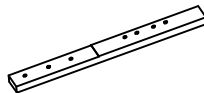

Headboard Leg - (L)

#3 1pc

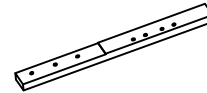

Headboard Leg - (R)

PART LIST OF FOOTBOARD

#4 1pc

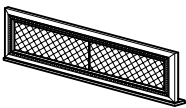

Footboard

#5 2pcs

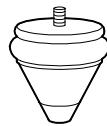

Bun Foot

#6 5pcs



Slat

#7 5pcs



Slat Support Leg
(300 x 30 x 30)

PART LIST OF SIDE RAIL

#8 2pcs



Side Rail

HARDWARE

HARDWARE PACK IN HEADBOARD

#A 1pc



Allen Key

#B 6pcs



JCBC - M6 x 35mm

#C 6pcs



M6 Spring Washer

#D 6pcs



M6 Flat Washer

#E 1pc



AC Adaptor

HARDWARE PACK IN FOOTBOARD

#F 1pc



Allen Key

#G 5pcs



JCBC - M6 x 35mm

#H 5pcs



M6 Spring Washer

#I 10pcs

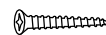

Screw 32mm

#J 5pcs



Adjustable Leveller

HARDWARE PACK IN SIDE RAIL

#K 1pc



Allen Key

#L 8pcs



JCBC - 5/16" x 20mm

#M 8pcs













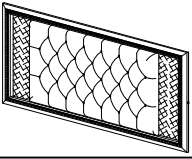

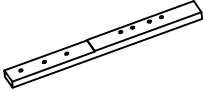

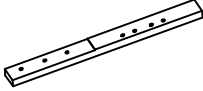

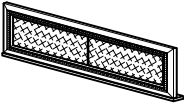

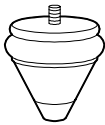
M8 Spring Washer

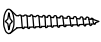
#N 8pcs



5/16" Flat Washer

CM7584EK POINT 3 CARTONS

Carton	Designation		Part	Hardware
CM7584EK-1	Headboard (1pc)	#1		 #A x 1pc  #B x 6pcs
	Headboard Leg - (L) (1pc)	#2		 #C x 6pcs  #D x 6pcs
	Headboard Leg - (R) (1pc)	#3		 #E x 1pc
CM7584EK-2	Footboard (1pc)	#4		 #F x 1pc  #G x 5pcs
	Bun Foot (2pcs)	#5		 #H x 5pcs  #I x 10pcs
	Slat (5pcs)	#6		 #J x 5pcs
	Slat Support Leg (5pcs)	#7		
CM7584EK-3	Side Rail (2pcs)	#8		 #K x 1pc  #L x 8pcs
				 #M x 8pcs  #N x 8pcs

ASSEMBLY INSTRUCTIONS

- 1
- Part #1 x 1pc
 - Part #2 x 1pc
 - Part #3 x 1pc
 - Hardware #A x 1pc
 - Hardware #B x 6pcs
 - Hardware #C x 6pcs
 - Hardware #D x 6pcs

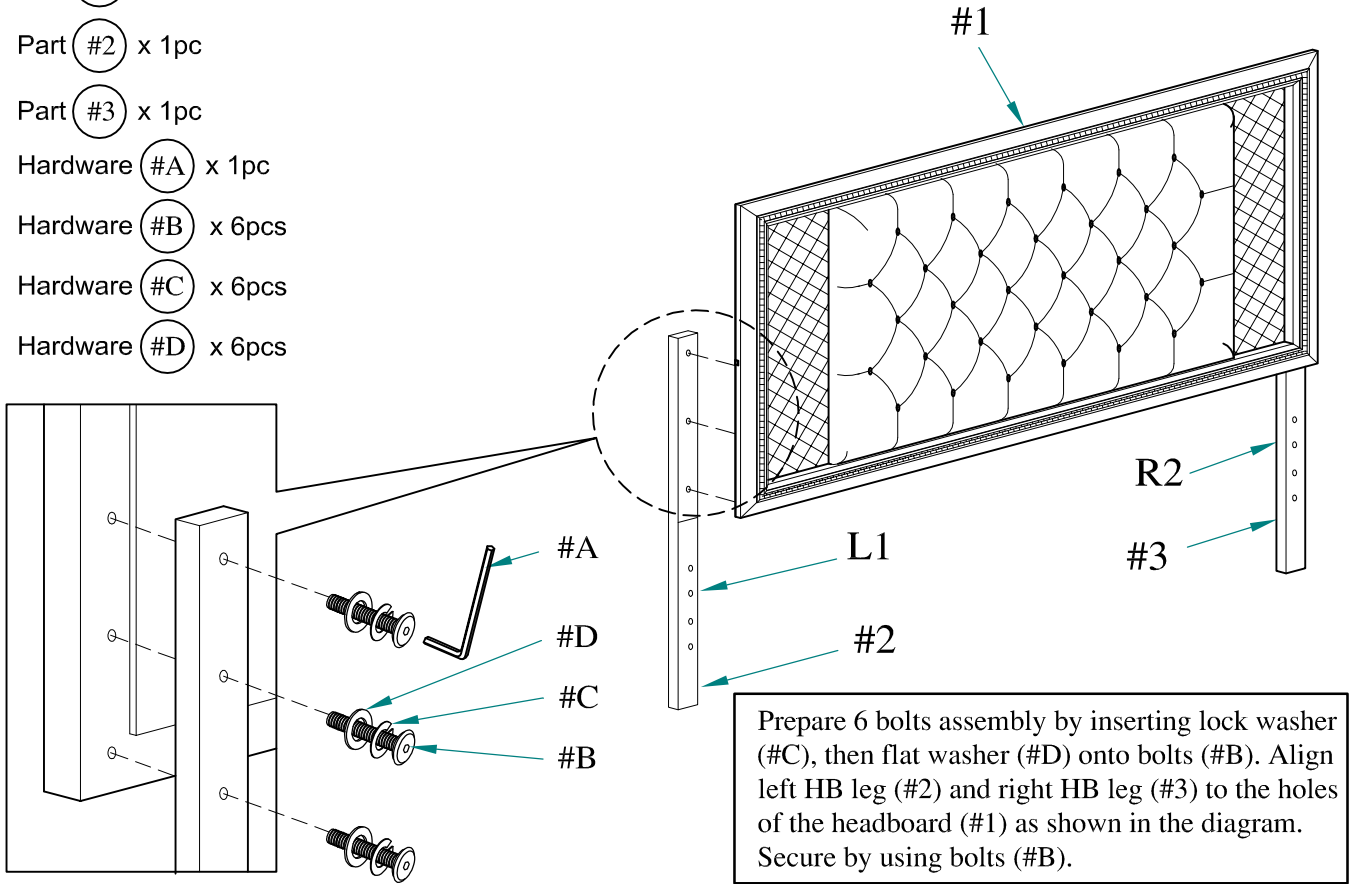

- 2
- Hardware #E x 1pc

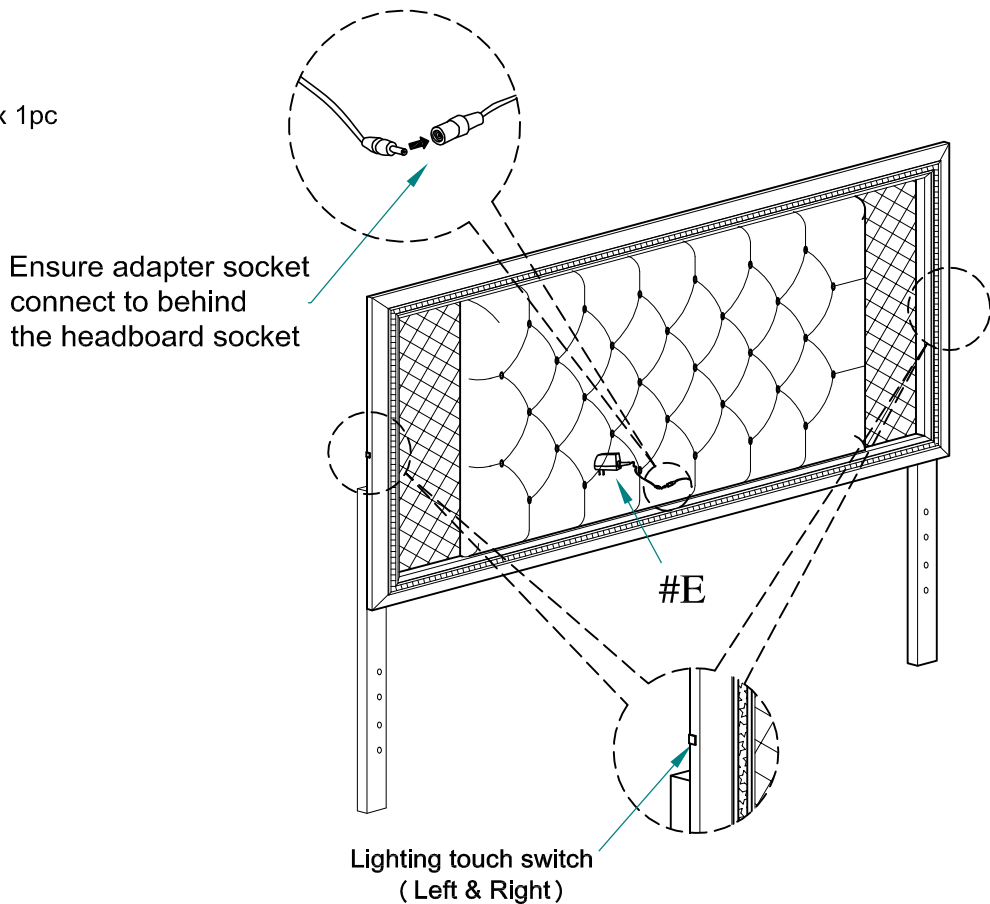

ASSEMBLY INSTRUCTIONS

3

Part (#4) x 1pc

Part (#5) x 2pcs

Bun Foot cover

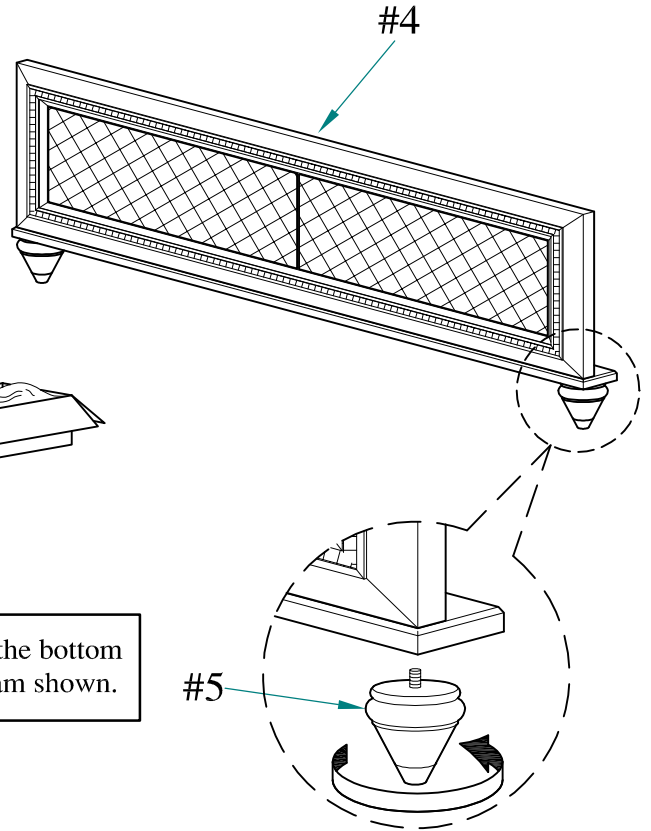
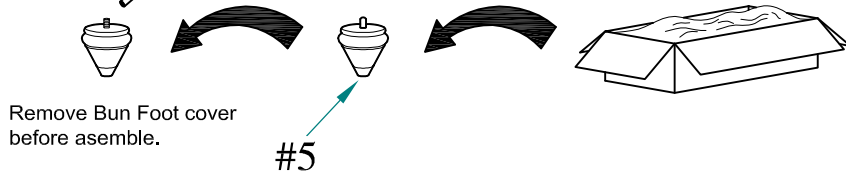

4

Part (#1) x 1pc

Part (#4) x 1pc

Part (#8) x 2pcs

Hardware (#K) x 1pc

Hardware (#L) x 8pcs

Hardware (#M) x 8pcs

Hardware (#N) x 8pcs

Prepare 8 bolts assembly by inserting lock washer (#M), then flat washer (#N) onto bolts (#L). Secure the half bolts to the HB Leg & Footboard, align and hook side rails (#8) to the bolts of the headboard (#1) and footboard (#4) as shown in the diagram. Tighten all bolt & make sure it is firmly secured.

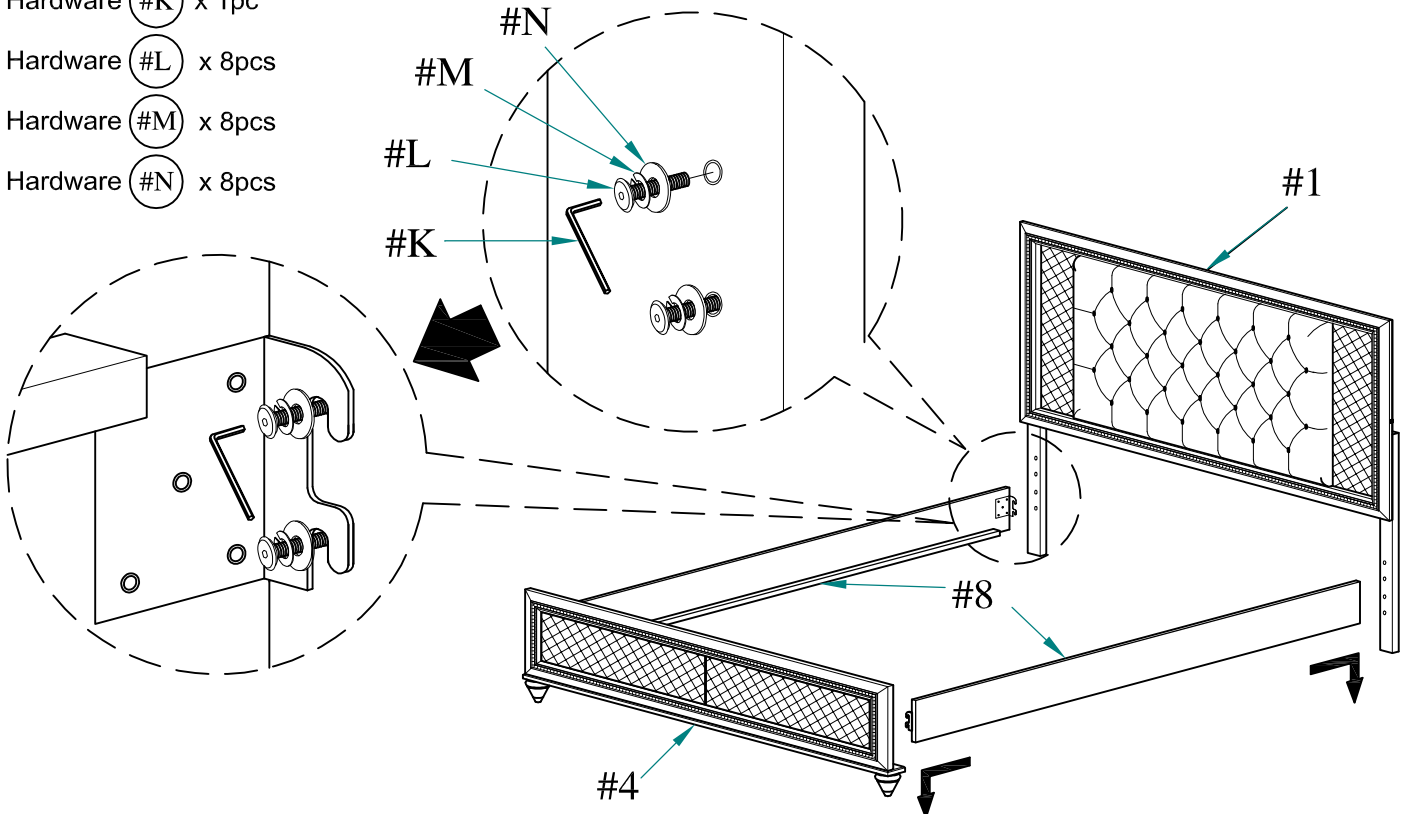

ASSEMBLY INSTRUCTIONS

5

Part #6 x 5pcs

Part #7 x 5pcs

Hardware #F x 1pc

Hardware #G x 5pcs

Hardware #H x 5pcs

Hardware #I x 10pcs

Hardware #J x 5pcs

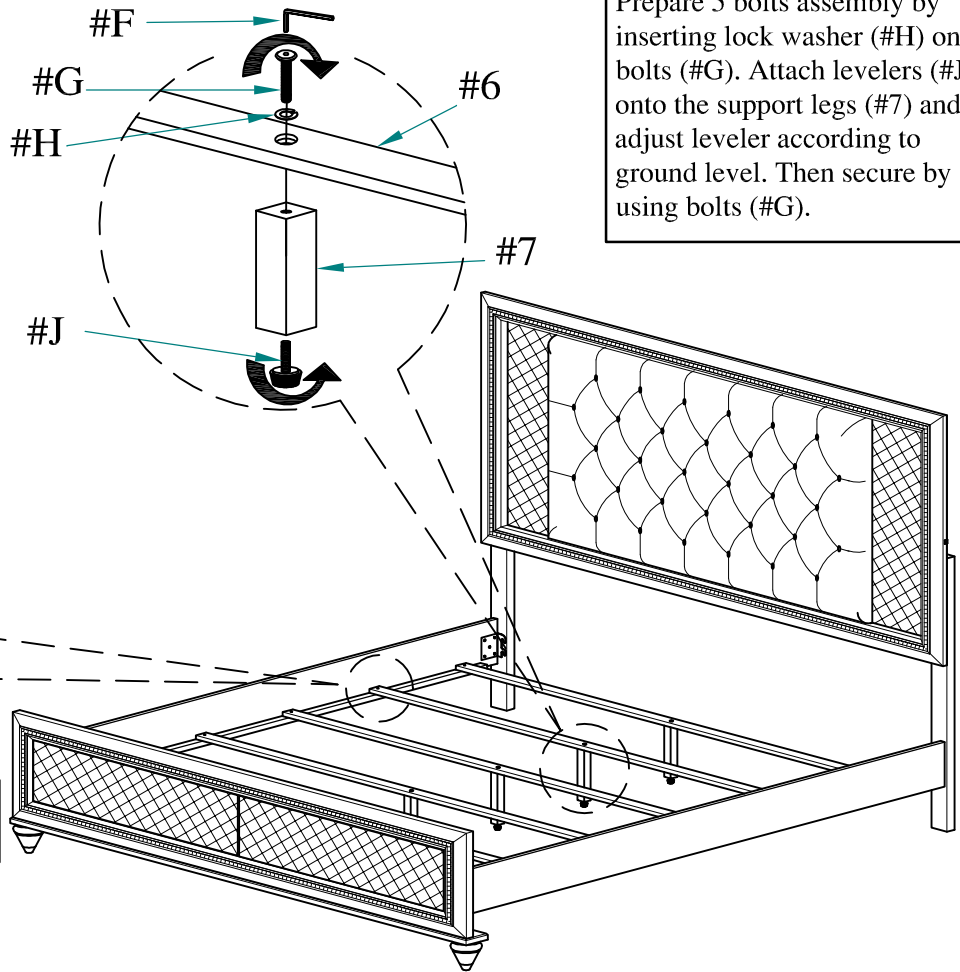

Prepare 5 bolts assembly by inserting lock washer (#H) onto bolts (#G). Attach levelers (#J) onto the support legs (#7) and adjust leveler according to ground level. Then secure by using bolts (#G).

Align slats (#6) to the side rails, then secure by using screws (#I).

6

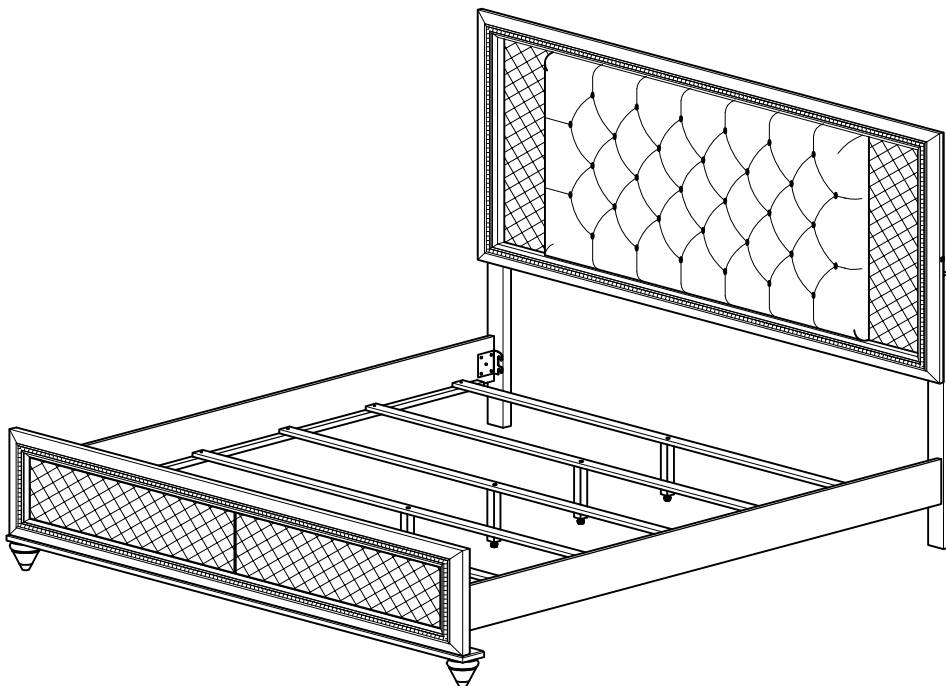

ASSEMBLY COMPLETED



Please ensure the furniture rests on an even and flat surface. If the product wobbles or feels loose, double-check all bolts and/or screws are properly tightened and secured.



Keep this handy!

Please retain this instruction manual and any order-related information for future reference.



Lift, don't drag!

To avoid damage to product please always LIFT the product when transporting or adjusting the placement.