



Furniture of America[®]

E-Commerce by Enitial Lab

ASSEMBLY INSTRUCTIONS

MODEL #

CM7550CK

Questions?

GIVE US A CALL: 1-888-980-5122
MON – FRI 8:30AM – 5:30PM (PST)

TOOLS REQUIRED



Allen Wrench

(Included)



**Phillips
Screwdriver**

(Not Included)

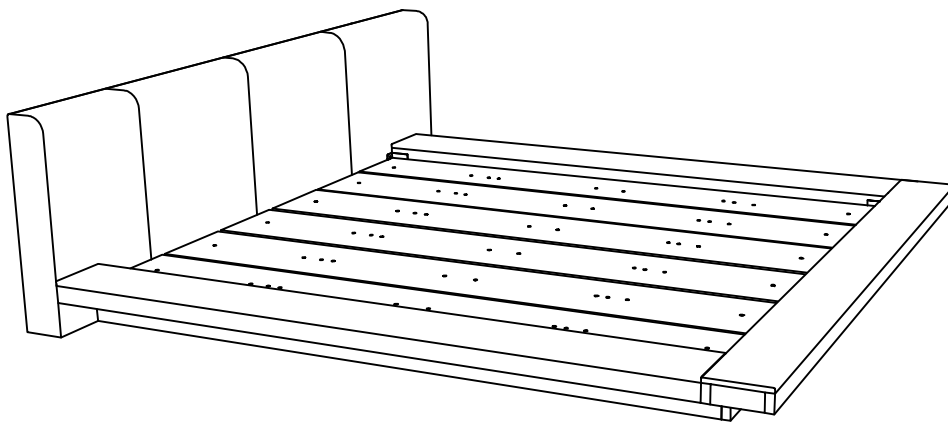

**3 - People
Recommended**

ASSEMBLY RATING



EASY —————> DIFFICULT

The Assembly Rating is a 5-point system showing the level of effort needed to assemble a specific product.



FOA Intro

Thank you for your purchase!

We hope you enjoy this new addition to your home for many years to come.

Our commitment to providing quality products does not simply end when you purchase our product. We fully stand behind our products from start to finish. Our customer service department is available Monday – Friday 8:30 AM – 5:30 PM Pacific and can help with assembly questions as well as, if necessary, replacing damaged or missing parts. To help expedite our service, please have these assembly instructions readily available, along with your order receipt.

 **Consumer Hotline**
Toll-Free 1-888-980-5122

 **WEBSITE**
www.foagroup.com

    foagroup

 **Monday to Friday**
8:30AM- 5:30PM (PST)

 **E-MAIL**
cs.ec@foagroup.com

 FurnitureOfAmerica

CHECK BEFORE STARTING

Are you missing anything?

Double-check all parts, hardware and accessories listed on Page 6 are accounted for.

Should we send any replacements?

Are there any irregularities or flaws in the parts? We can send replacements!

Check out our Quick Tips!

We recommend reviewing the pre-assembly handouts. Even experts need a refresher now and then!

Prep Time!

Please review the assembly instructions and all diagrams prior to assembling. Arrange parts as recommended on Page 7 and group identical hardware together to make assembling easier.

PRE ASSEMBLY INTRODUCTION

We understand building ready-to-assemble furniture can be a challenging experience for some. To help avoid confusion, we have provided some helpful tips that may speed up the process.

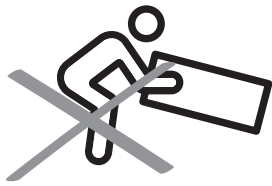

Teamwork

ALWAYS have at least two people to help with transporting and assembling the product to avoid potential injury and/or damage.

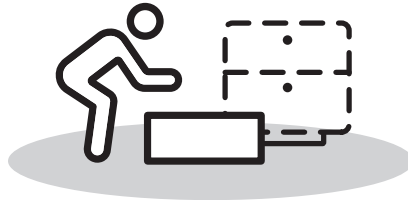
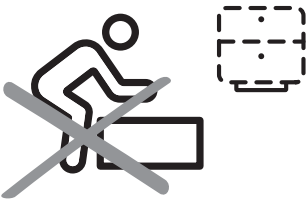

Suitable Location

Assembling near the area of the intended location is highly recommended.



Sufficient Space

Make sure you have enough space to move around during the assembly.



Avoid Scratches

Use cardboard, blankets or a carpeted area while assembling furniture to prevent scratches.

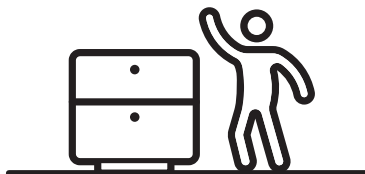
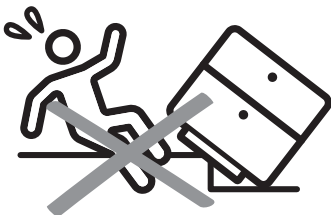

Flat Surface

Make sure the furniture rests on a flat and level surface with each leg evenly touching the floor.

ASSEMBLY AND CARE ADVICE



FAILURE TO FOLLOW THE GUIDELINES BELOW MAY RESULT IN INJURY AND/OR PROPERTY DAMAGE.



Position each part correctly and insert screws or bolts into their respective holes.



Use the appropriate hand tools or power tools for assembly. Select steps, such as tightening screws and/or bolts, may require hand tools to avoid causing damage during assembly.

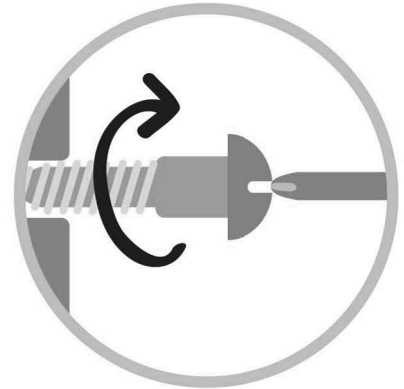

Turn clockwise to tighten and only tighten when step is completed or when instructed to do so.



Save the instructions and store any supplied tools for later maintenance.



After two weeks, check and tighten any loose hardware and repeat again every six months thereafter.

IT IS THE USER'S RESPONSIBILITY TO MAINTAIN THE FURNITURE. THE HARDWARE MAY LOOSEN OVER TIME AND MAY CAUSE THE FURNITURE TO BE WOBBLY AND UNABLE TO SUPPORT ITS INTENDED WEIGHT CAPACITY. THIS MAY LEAD TO COLLAPSE AND MAY CAUSE SERIOUS INJURY.

CALIFORNIA KING BED

CM7550CK

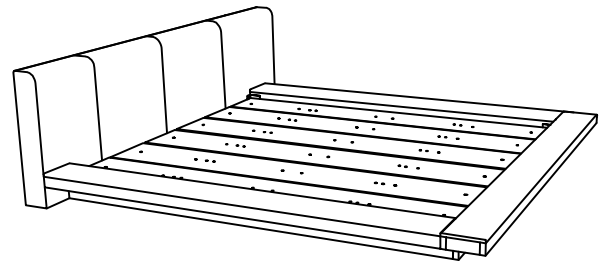
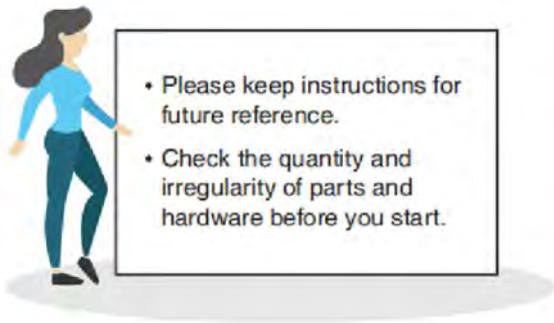

PARTS

#1 1pc

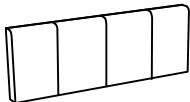

Headboard

#2 1pc



Footboard

#3 2pcs

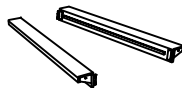

Side Rail

#4 3pcs



Bed Slat w/o marking
-18 x 45 x 1845

#5 2pcs



Bed Slat with marking
-18 x 45 x 1845

#6 10pcs



Bed Slat Support
-30 x 30 x 82

#7 6pcs

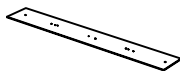

Concealed Panel
-9 x 295 x 2164

HARDWARE

#A 10pcs

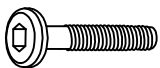

Bolt 1/4" x 2"

#B 4pcs

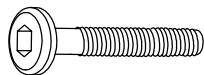

Bolt 5/16" x 2-3/4"

#C 8pcs

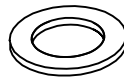

Flat Washer

#D 4pcs

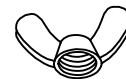

Wing Nut M8

#E 1pc

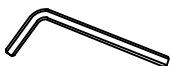

Allen Key M4

#F 1pc

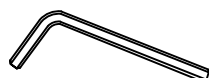

Allen Key M5

#G 10pcs

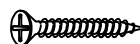







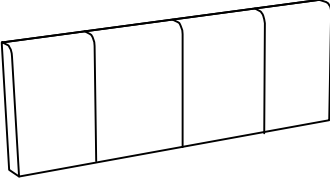
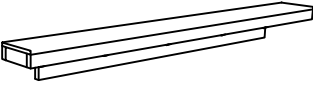
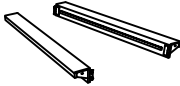
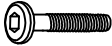
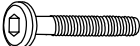

CSK m4 x 32mm

#H 30pcs

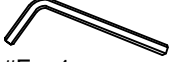
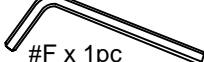

P.H Screw m3.5x20mm

CM7550CK is packed in 3 cartons

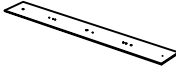
Carton	Designation	Part		Hardware
CM7550CK-HB	Headboard (1pc)	#1		
CM7550CK-FB	Footboard (1pc)	#2		
CM7550CK-R	Side Rail (2pcs)	#3		 #A x 10pcs  #B x 4pcs  #C x 8pcs  #D x 4pcs  #E x 1pc  #F x 1pc  #G x 10pcs  #H x 30pcs
	Bed Slat w/o marking (3pcs)	#4		
	Bed Slat with marking (2pcs)	#5		
	Bed Slat Support (10pcs)	#6		
	Concealed Panel (6pcs)	#7		

ASSEMBLY INSTRUCTIONS

1

Part #1 x1pc Hardware #B x4pcs

Part #2 x1pc Hardware #C x8pcs

Part #3 x2pcs Hardware #D x4pcs

1) Prepare 4 bolts assembly by inserting (#C) onto bolts (#B). Insert bolts (#B) to headboard (#1) 75% in, then hook side rails (#3) to the bolts (#B) on headboard (#1). Secure by inserting washer (#C) and wing nut (#D) from the back of the headboard (#1) onto bolts (#B).

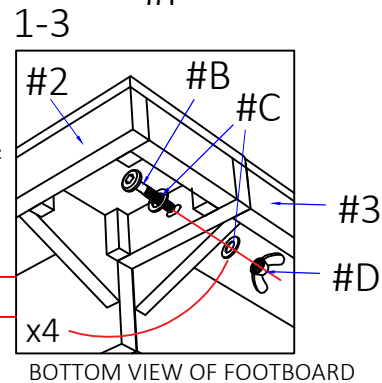
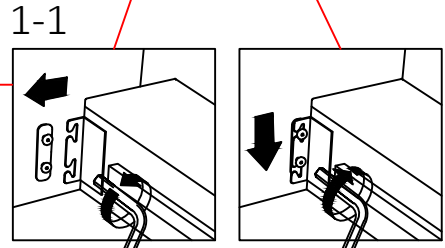
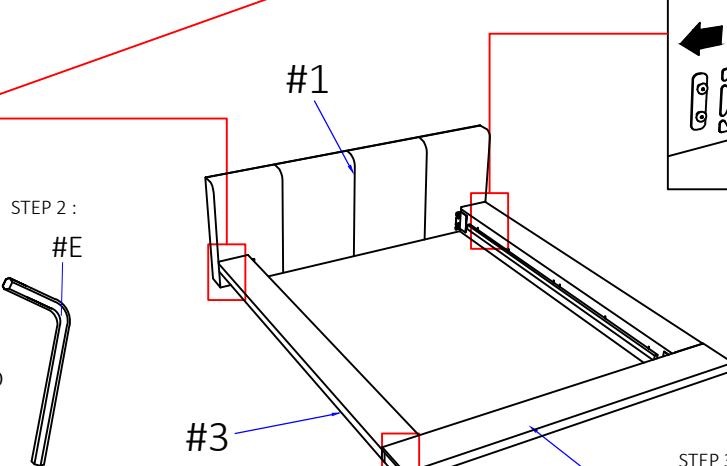
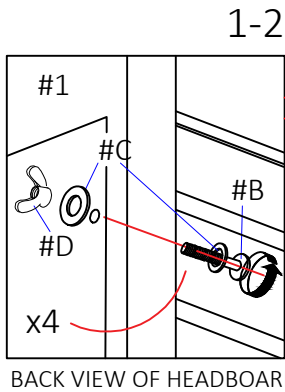

2) Align footboard (#2) to the bottom holes of the side rails (#3). Insert bolts (#B) from footboard (#2) to side rails (#3), then secure by inserting washer (#C) and wing nut (#D) from the other end of the bolts (#B).

2

Part #4 x3pcs

Part #5 x2pcs

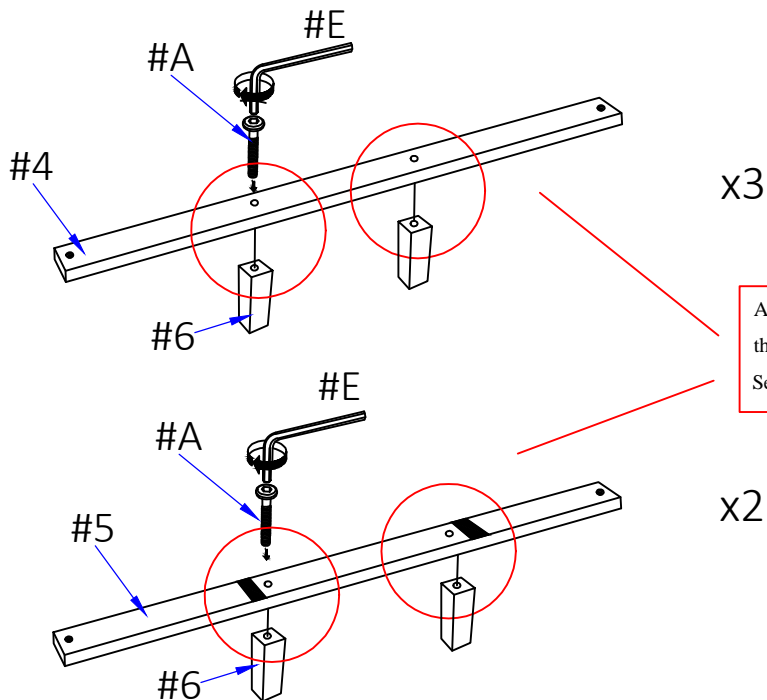

Align slat support legs (#6) to the holes of the slats (#4,5). Secure by using bolts (#A).

ASSEMBLY INSTRUCTIONS

3

Hardware #G x10pcs

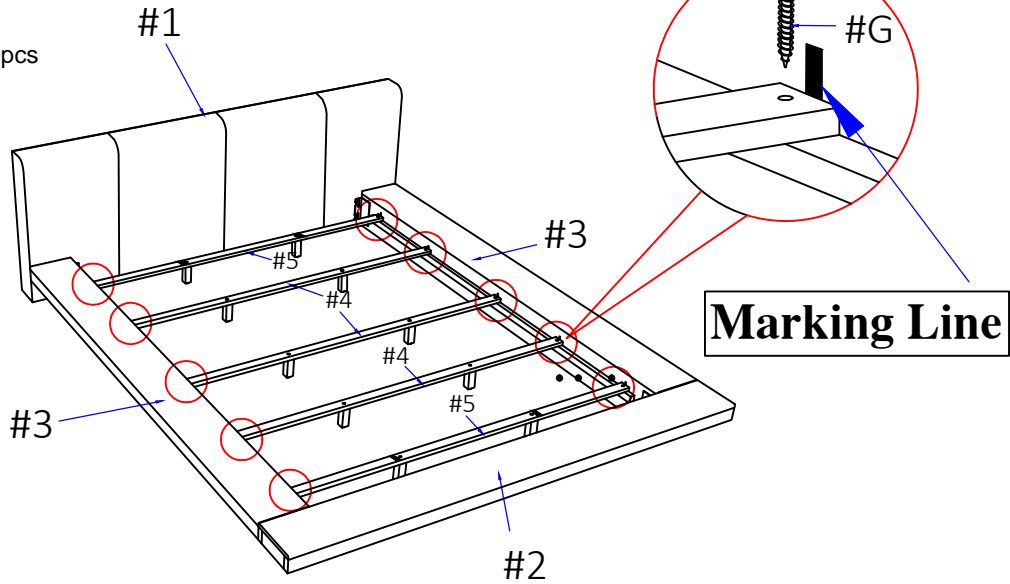

4

Part #7 x5pcs
Hardware #H x25pcs

- 1) Please refer to steps (#5) on how to align and place concealed panels(#7) correctly.
- 2) Secure concealed panels (#7) to bed slats by using screws (#H).

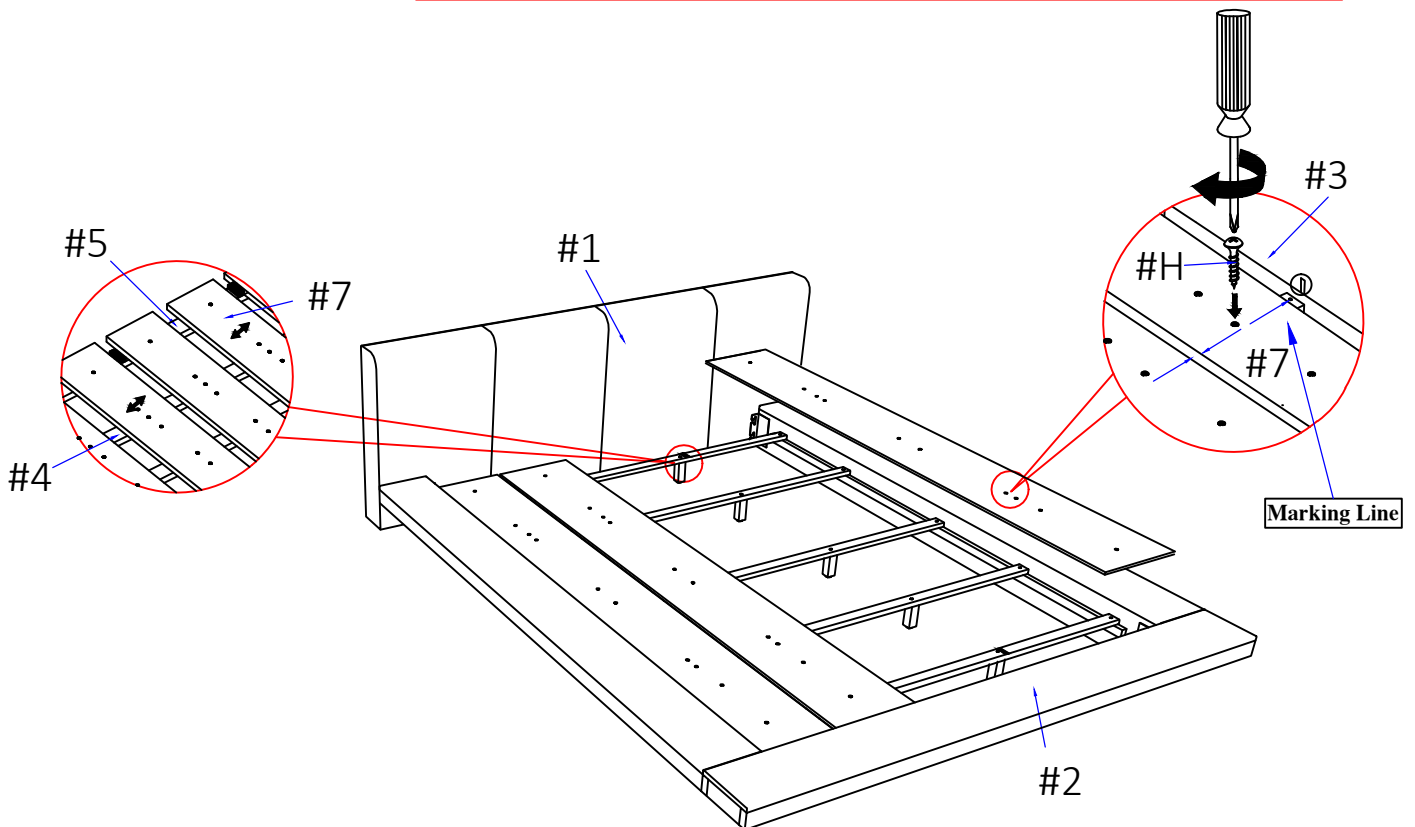

ASSEMBLY INSTRUCTIONS

This is how the concealed panel (#7) look like on the bed from a high view.

5

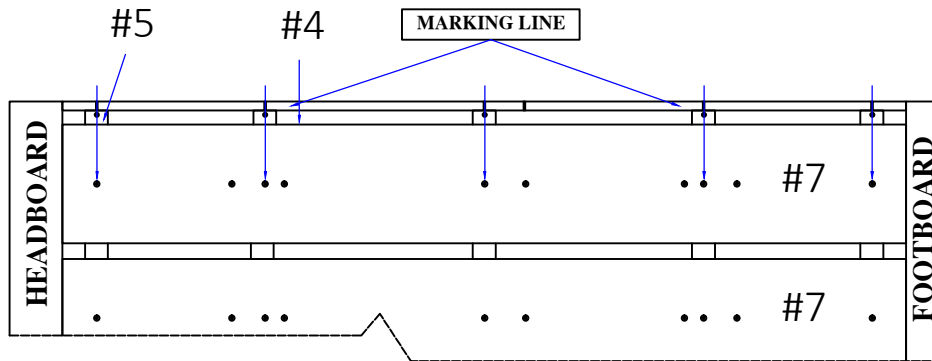

6

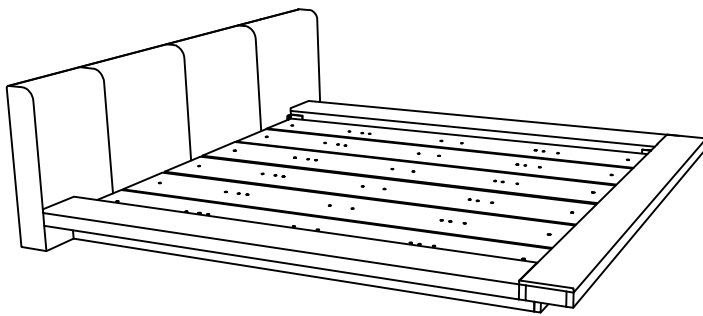

ASSEMBLY COMPLETED



Please ensure the furniture rests on an even and flat surface. If the product wobbles or feels loose, double-check all bolts and/or screws are properly tightened and secured.



Keep this handy!

Please retain this instruction manual and any order-related information for future reference.



Lift, don't drag!

To avoid damage to product please always LIFT the product when transporting or adjusting the placement.