

ASSEMBLY INSTRUCTIONS

Questions?

GIVE US A CALL: 1-888-980-5122
MON – FRI 8:30AM – 5:30PM (PT)

TOOLS REQUIRED



Allen Wrench

(Included)



Wrench

(Included)

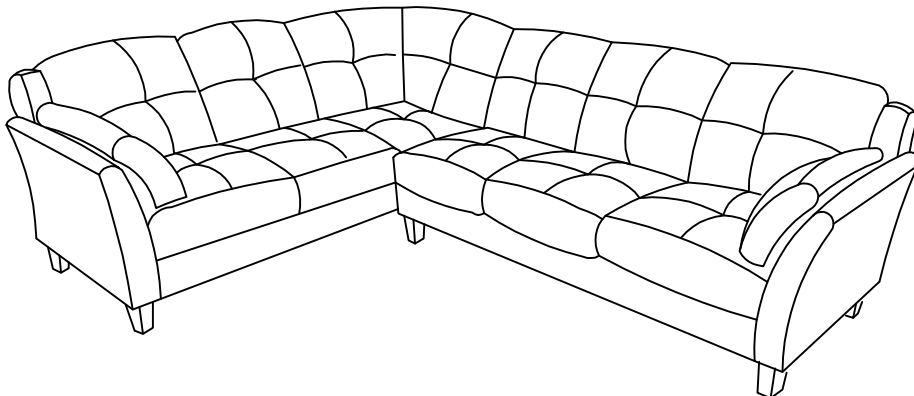

**2 - People
Recommended**

ASSEMBLY RATING

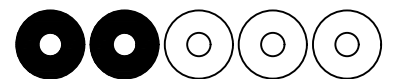

EASY —————> DIFFICULT

The Assembly Rating is a 5-point system showing the level of effort needed to assemble a specific product.



FOA Intro

Thank you for your purchase!

We hope you enjoy this new addition to your home for many years to come.

Our commitment to providing quality products does not simply end when you purchase our product. We fully stand behind our products from start to finish. Our customer service department is available Monday – Friday 8:30 AM – 5:30 PM Pacific Time and can help with assembly questions as well as, if necessary, replacing damaged or missing parts. To help expedite our service, please have these assembly instructions readily available, along with your order receipt.

 **Consumer Hotline**
Toll-Free 1-888-980-5122

 **WEBSITE**
www.foagroup.com

    foagroup

 **Monday to Friday**
8:30AM- 5:30PM (PT)

 **E-MAIL**
cs.ec@foagroup.com

 FurnitureOfAmerica

CHECK BEFORE STARTING

Are you missing anything?
Double-check all parts, hardware and accessories listed are all accounted for.

Should we send any replacements?
Are there any irregularities or flaws in the parts? We can send replacements!

Check out our Quick Tips!
We recommend reviewing the pre-assembly handouts. Even experts need a refresher now and then!

Prep Time!
Please review the assembly instructions and all diagrams prior to assembling.

PRE ASSEMBLY INTRODUCTION

We understand building ready-to-assemble furniture can be a challenging experience for some. To help avoid confusion, we have provided some helpful tips that may speed up the process.

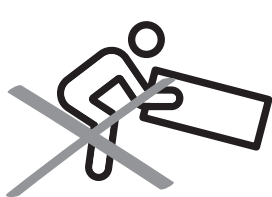

Teamwork

ALWAYS have at least two people to help with transporting and assembling the product to avoid potential injury and/or damage.

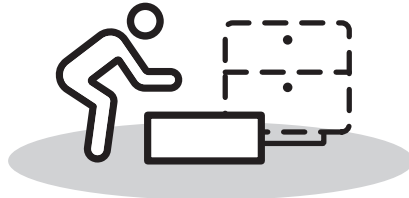
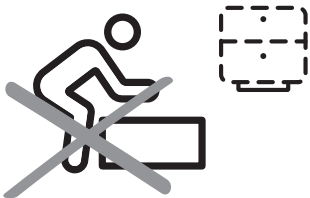

Suitable Location

Assembling near the area of the intended location is highly recommended.



Sufficient Space

Make sure you have enough space to move around during the assembly.

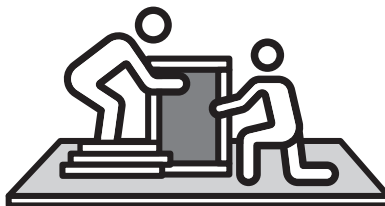

Avoid Scratches

Use cardboard, blankets or a carpeted area while assembling furniture to prevent to prevent scratches and damages.

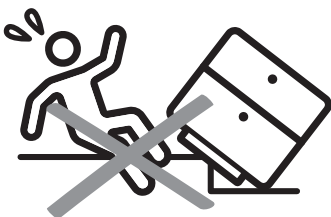

Flat Surface

Make sure the furniture rests on a flat and level surface with each leg evenly touching the floor.

ASSEMBLY AND CARE ADVICE



FAILURE TO FOLLOW THE GUIDELINES BELOW MAY RESULT IN INJURY AND/OR PROPERTY DAMAGE.



Position each part correctly and insert screws or bolts into their respective holes.



Turn clockwise to tighten and only tighten when step is completed or when instructed to do so.



Use the appropriate hand tools or power tools for assembly. Select steps, such as tightening screws and/or bolts, may require hand tools to avoid causing damage during assembly.



Save the instructions and store any supplied tools for later maintenance.



After two weeks, check and tighten any loose hardware and repeat again every six months thereafter.

IT IS THE USER'S RESPONSIBILITY TO MAINTAIN THE FURNITURE. THE HARDWARE MAY LOOSEN OVER TIME AND MAY CAUSE THE FURNITURE TO BE WOBBLY AND UNABLE TO SUPPORT ITS INTENDED WEIGHT CAPACITY. THIS MAY LEAD TO COLLAPSE AND MAY CAUSE SERIOUS INJURY.

CORNER SOFA

CM6268 / CM6368

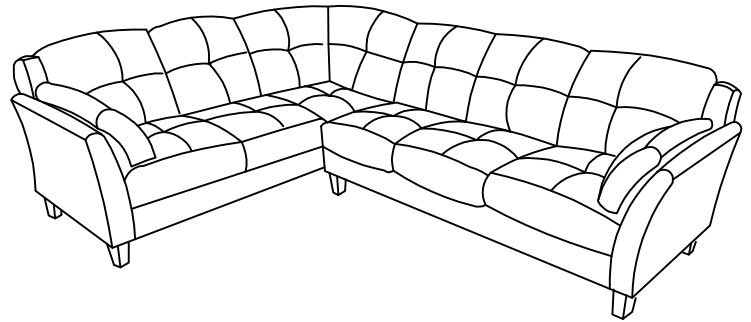
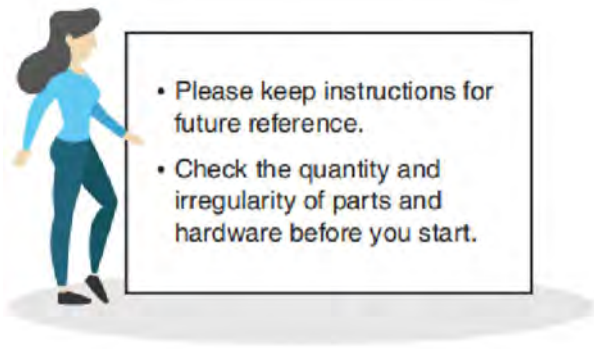

PARTS

#1 1pc

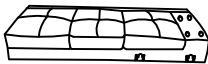

Right Sofa Seat

#2 1pc



Left Sofa Seat

#3 2pcs



Armrest (L & R)

#4 2pcs



Armrest Support (L & R)

#5 1pc

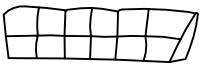

Right Backrest

#6 1pc



Left Backrest

#7 2pcs



Armrest Cushion (L & R)

#8 1pc



Corner Backrest

#9 8pcs

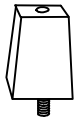

Leg

HARDWARE

#A 2pcs

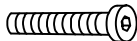

Bolt
5/16" x 4"

#E 23pcs

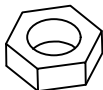

Nut

#B 2pcs

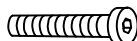

Bolt
5/16" x 2-1/2"

#F 1pc



Allen Wrench

#C 23pcs



Threaded Stud
5/16" x 3-3/4"

#G 1pc













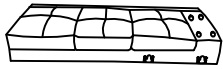
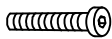
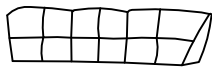
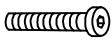



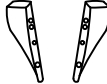

Wrench

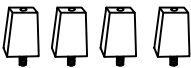
#D 27pcs

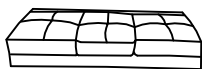
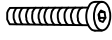
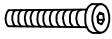
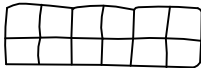

Flat Washer

CM6268 CM6368 is packed in 2 cases

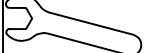
Carton	Disignation		Part	Hardware
CM6268 / CM6368 -1	Right Sofa Seat	#1		 #A x1pc
	Right Backrest	#5		 #B x1pc
	Corner Backrest	#8		 #C x14pcs
	Armrest Cushion (L & R)	#7		 #D x16pcs  #E x14pcs
	Armrest Support (L & R)	#4		 #F x1pc
	Leg	#9		 #G x1pc
CM6268/CM6368 -2	Left Sofa Seat	#2		 #A x1pc  #B x1pc
	Left Backrest	#6		 #C x9pcs  #D x11pcs
	Armrest (L & R)	#3		 #E x9pcs  #F x1pc
	Leg	#9		 #G x1pc

ASSEMBLY INSTRUCTIONS

1

- Part #3 x1pc
- Part #4 x1pc
- Hardware #A x1pc
- Hardware #B x1pc
- Hardware #D x2pcs
- Hardware #F x1pc

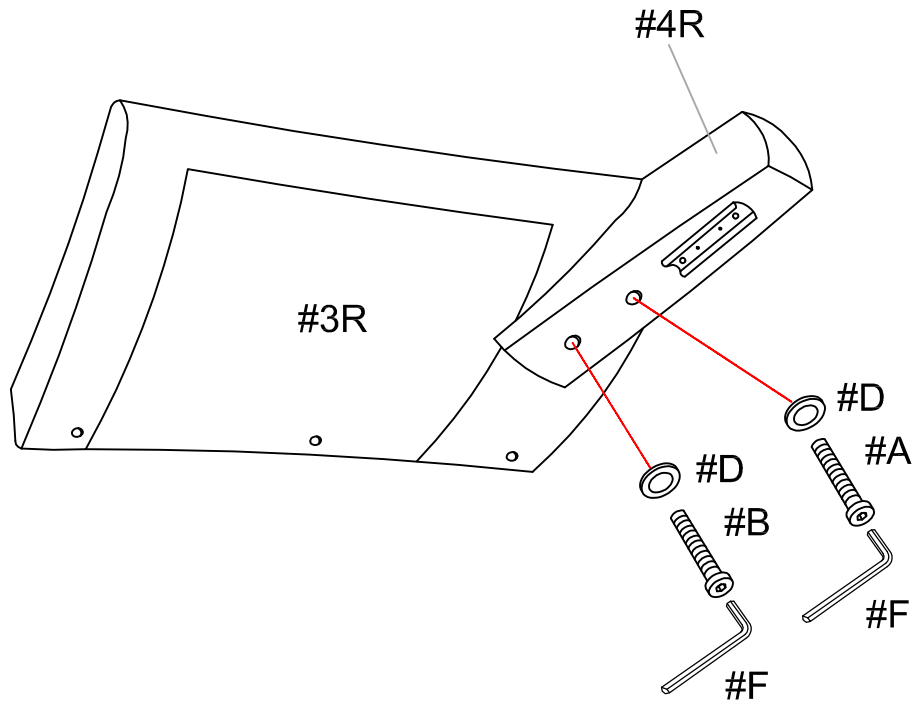

Align right armrest support (#4R) to the holes of the right armrest (#3R), then secure by using bolts (#A,B) with washers (#D).

2

- Part #1 x1pc
- Hardware #C x3pcs
- Hardware #D x3pcs
- Hardware #E x3pcs
- Hardware #G x1pc

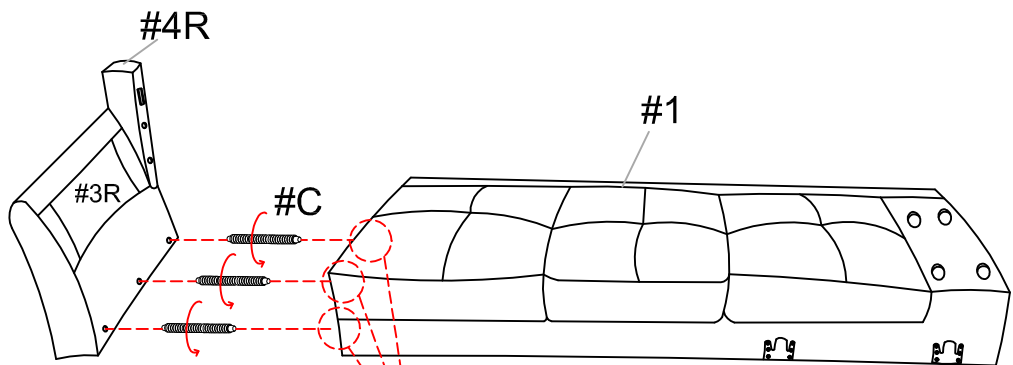

Insert 20% of the threaded studs (#C) into the holes of the right armrest (#3R). Align the armrest (#3R) to the right sofa seat (#1), then secure by using hexnut (#E) with washers (#D) to the threaded studs (#C).

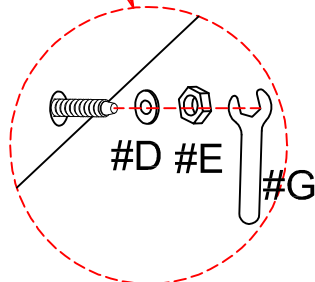

ASSEMBLY INSTRUCTIONS

3

- Part #5 x 1pc
- Hardware #C x 6pcs
- Hardware #D x 6pcs
- Hardware #E x 6pcs

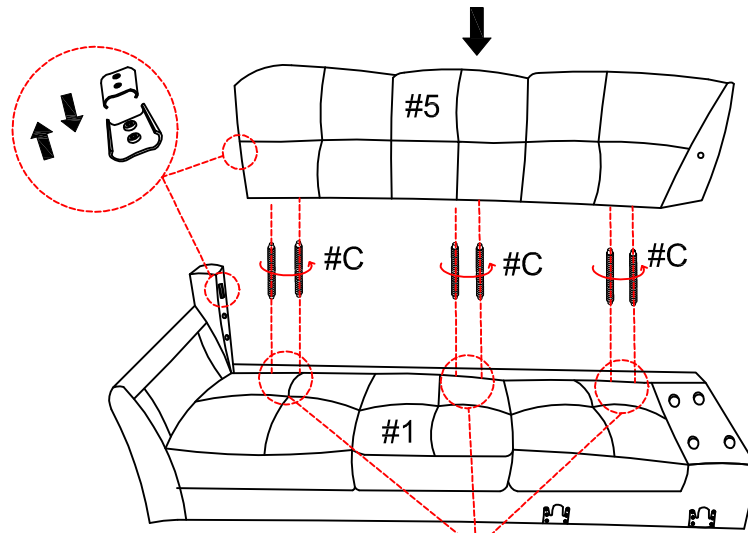

Insert 20% of the threaded studs (#C) into the holes of the backrest (#5). Align the backrest (#5) to the right sofa seat (#1) and the metal brackets of the armrest support, then secure by using hexnut (#E) with washers (#D) to the threaded studs (#C).

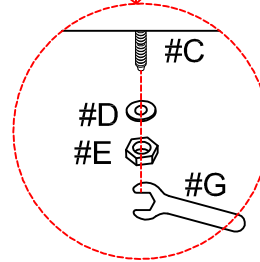

4

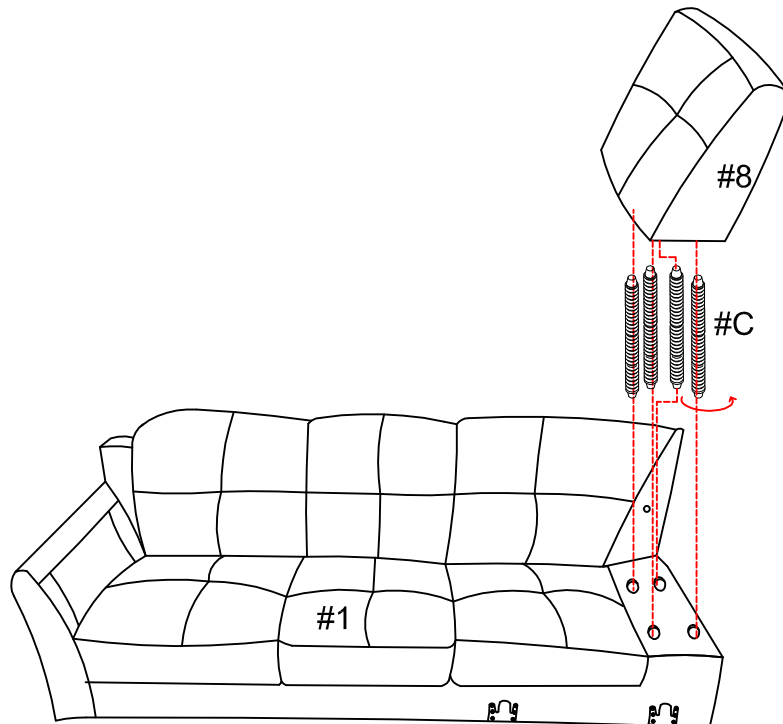

- Part #8 x 1pc
- Hardware #C x 4pcs
- Hardware #D x 4pcs
- Hardware #E x 4pcs

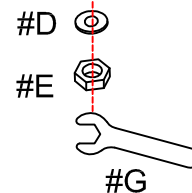

Insert 20% of the threaded studs (#C) into the holes of the corner backrest (#8). Align the corner backrest (#8) to the right sofa seat (#1), then secure by using hexnut (#E) with washers (#D) to the threaded studs (#C).



ASSEMBLY INSTRUCTIONS

- 5 Hardware  #C x 1pc
Hardware  #D x 1pc
Hardware  #E x 1pc

Secure corner backrest (#8) to backrest (#5) by using bolts (#C) with washers (#D) and hex nut (#E).

Velcro

Attach pillow (#7R) to the velcro of the armrest (#3R).

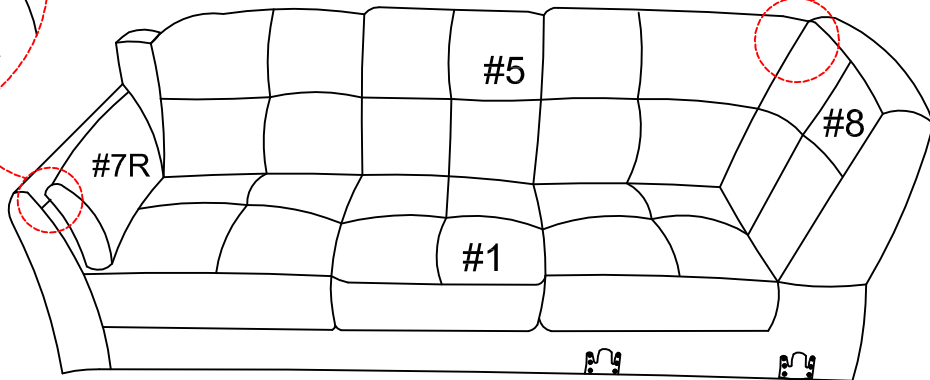
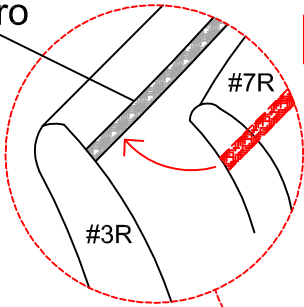
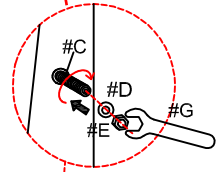

6

Part  #9 x 4pcs

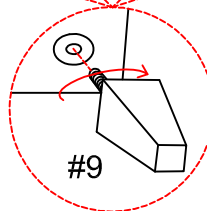
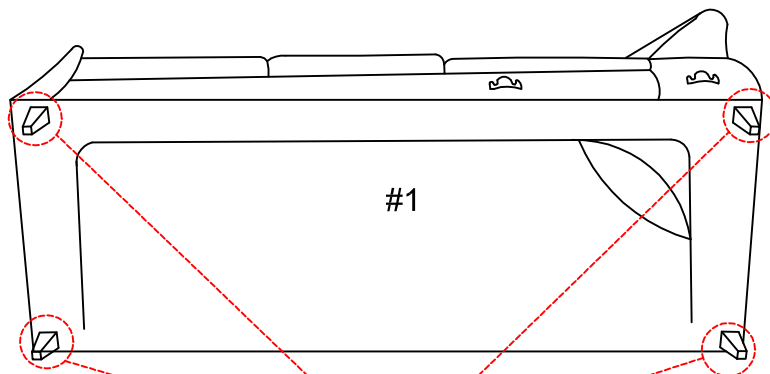

Attach legs (#9) to the bottom holes of the right sofa seat (#1).

ASSEMBLY INSTRUCTIONS

7

- Part #2 x1pc
- Part #3 x1pc
- Part #4 x1pcs
- Hardware #A x1pc
- Hardware #B x1pc
- Hardware #C x3pcs
- Hardware #D x5pcs
- Hardware #E x3pcs
- Hardware #G x1pc

Align left armrest support (#4L) to the holes of the left armrest (#3L), then secure by using bolts (#A,B) with washers (#D).

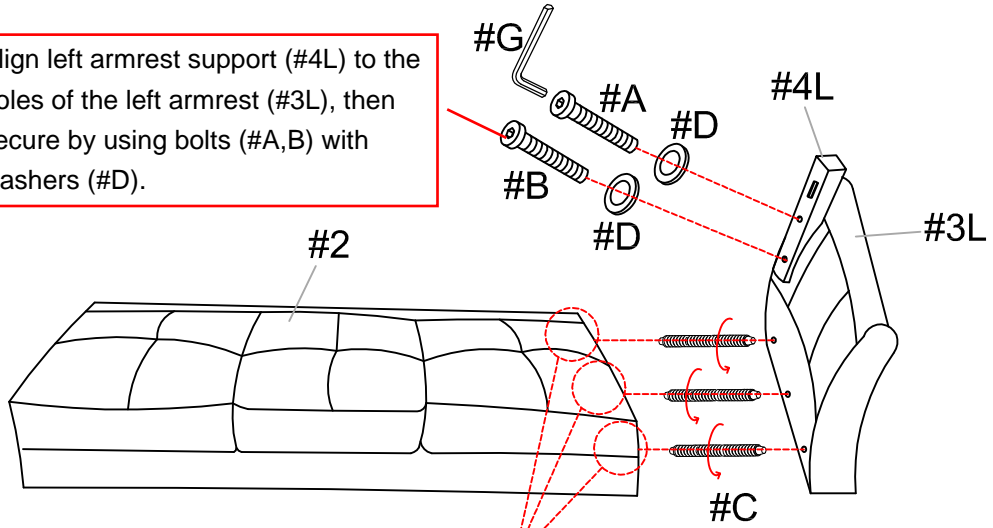

Insert 20% of the threaded studs (#C) into the holes of the left armrest (#3L). Align the armrest (#3L) to the left sofa seat (#2), then secure by using hexnut (#E) with washers (#D) to the threaded studs (#C).

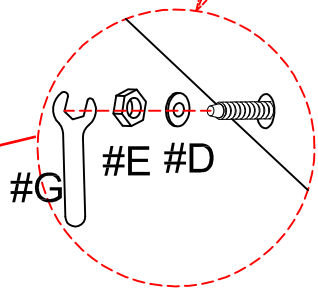

8

- Part #6 x1pc
- Hardware #C x6pcs
- Hardware #D x6pcs
- Hardware #E x6pcs
- Hardware #G x1pc

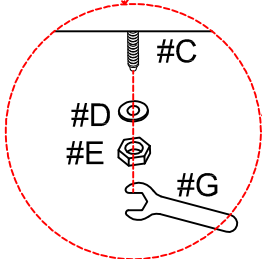
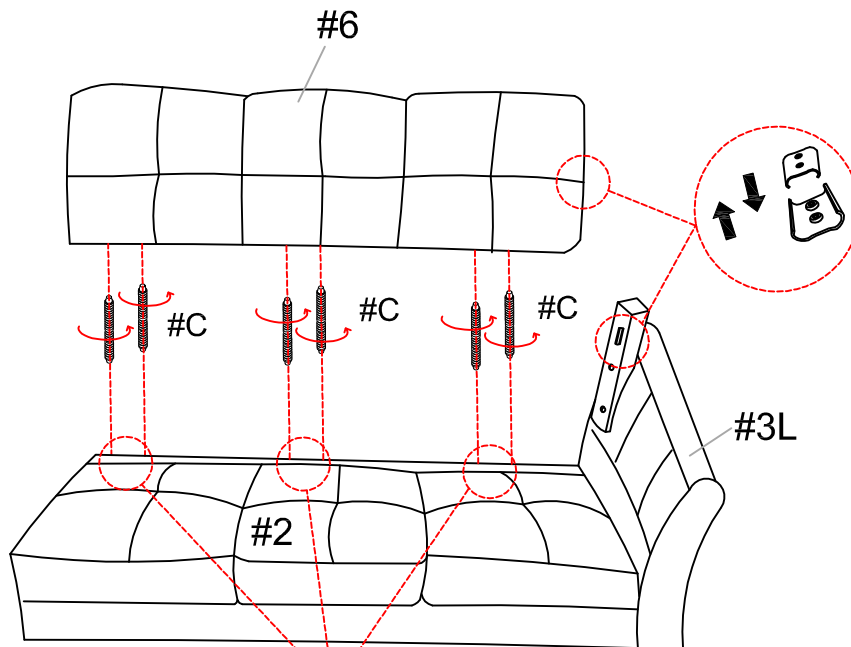

Insert 20% of the threaded studs (#C) into the holes of the backrest (#6). Align the backrest (#6) to the sofa seat (#2) and the metal brackets of the armrest support, then secure by using hexnut (#E) with washers (#D) to the threaded studs (#C).

ASSEMBLY INSTRUCTIONS

9

Part #7 x 1pc

Attach pillow (#7L) to the velcro of the armrest (#3L).

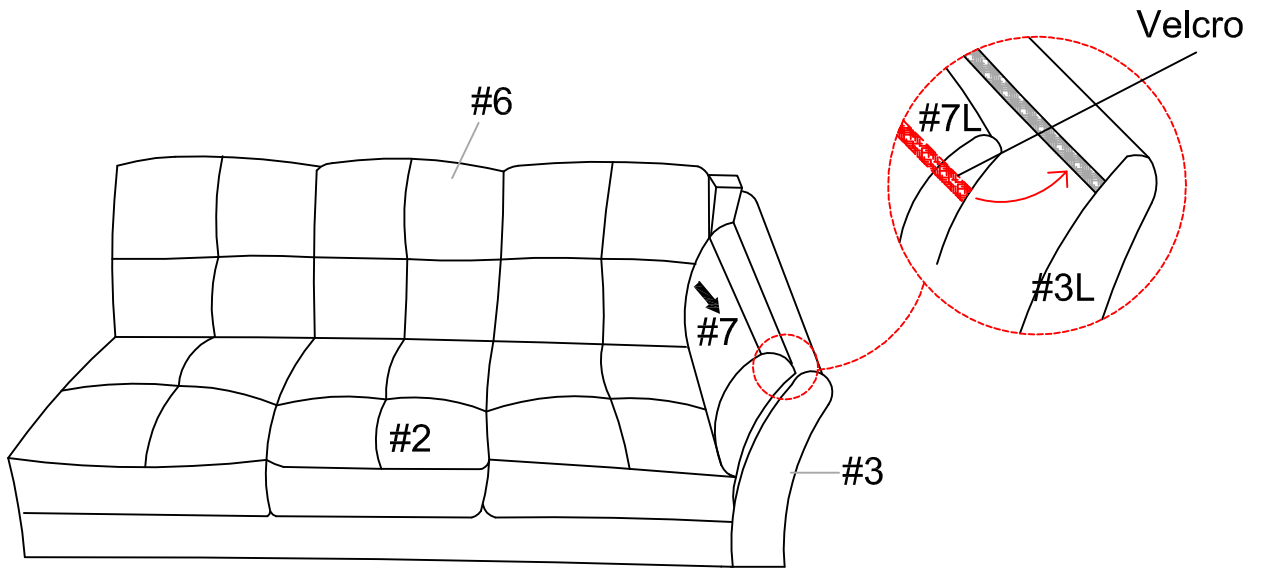

10

Part #9 x 4pcs

Attach legs (#9) to the bottom holes of the left sofa seat (#2).

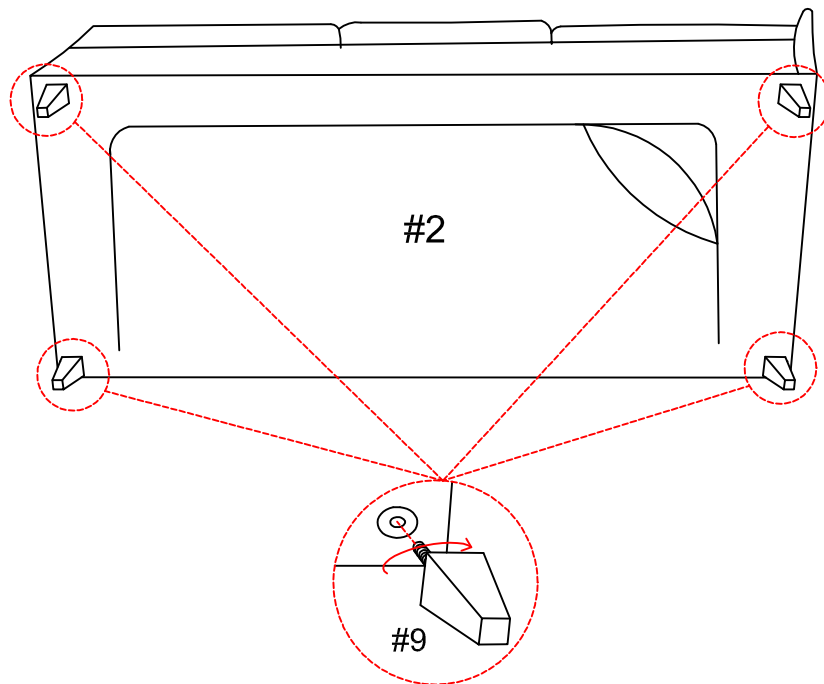

ASSEMBLY INSTRUCTIONS

11

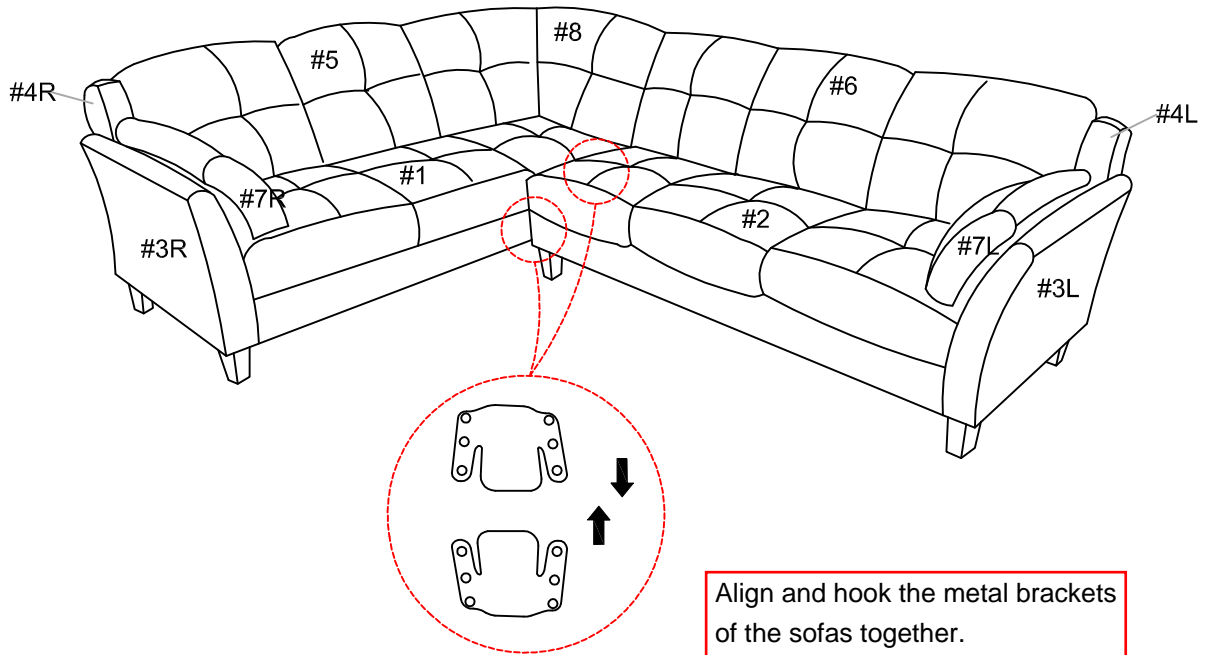

12

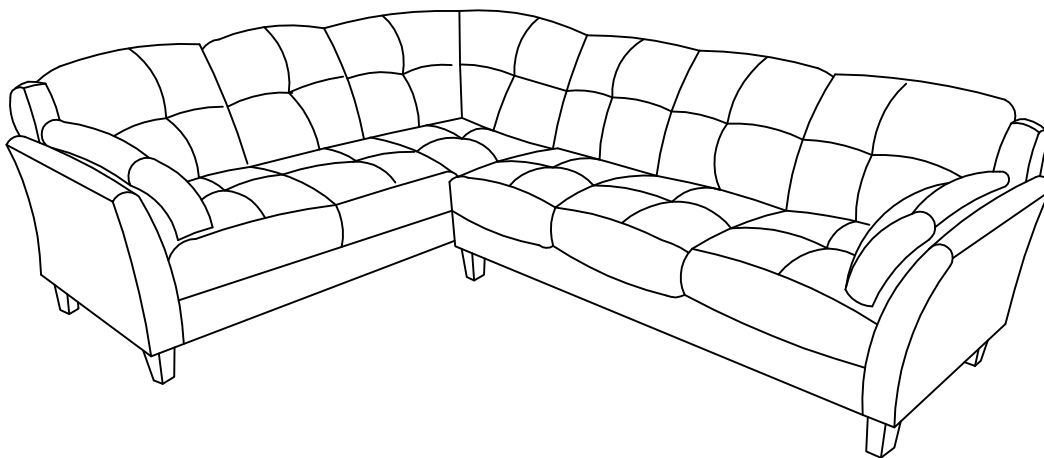

ASSEMBLY COMPLETED



Please ensure the furniture rests on an even and flat surface. If the product wobbles or feels loose, double-check all bolts and/or screws are properly tightened and secured.



Keep this handy!

Please retain this instruction manual and any order-related information for future reference.



Lift, don't drag!

To avoid damage to product please always LIFT the product when transporting or adjusting the placement.