

**Furniture of America**<sup>®</sup>

# Assembly Instructions

For more information contact our team: [service.ec@foagroup.com](mailto:service.ec@foagroup.com)

## CM-BK912F

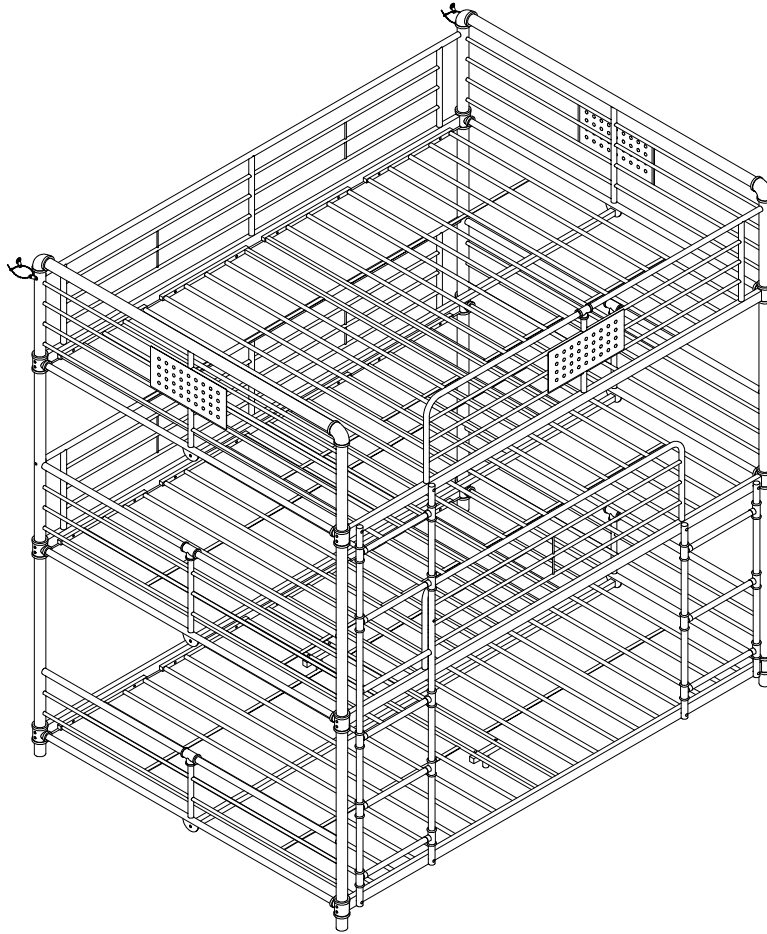

### ASSEMBLY RATING

The Assembly Rating is a 5-point system that shows the degree of effort needed in assembling a specific product (with 1 being easy and 5 being difficult). For some products, two persons are recommended.

EASY



DIFFICULT

### Tools Required For Assembly:

Allen Wrench

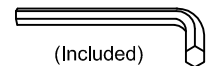

(Included)

Phillips Screwdriver



(Not Included)

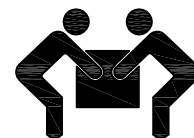

**2 PERSONS RECOMMENDED**

# ASSEMBLY & CARE ADVICE

FOR YOUR FURNITURE TO LAST, CORRECT ASSEMBLY AND PROPER MAINTENANCE ARE NECESSARY. PLEASE FOLLOW THE INFORMATION PROVIDED BELOW TO FULLY ENJOY YOUR FURNITURE.

## BASIC ASSEMBLY TECHNIQUES

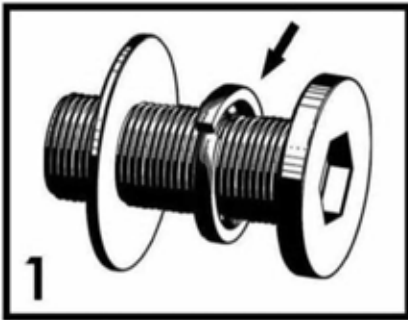

When lock or spring washer is used in an assembly, please make sure the lock or spring washer is placed between the larger flat washer and the head of the screw or bolt.

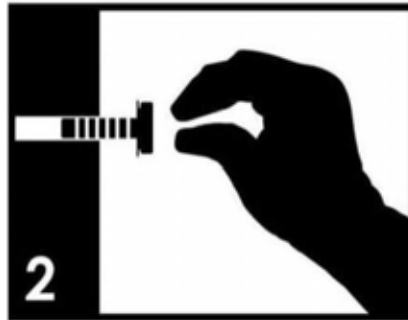

Position each part correctly and insert screws or bolts into their respective holes by hand tighten or using the proper hand tool. Only tighten when step is completed or when instructed to do so.

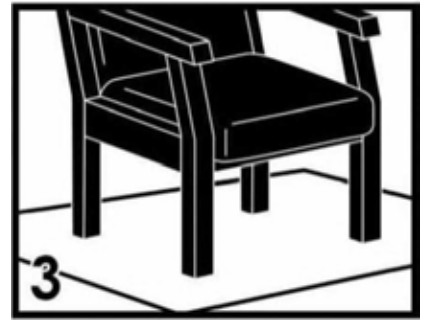

Use cardboard or carpet area when assembling furniture to prevent scratches. Make sure the furniture rests on a flat and level surface with each leg evenly touching the floor.

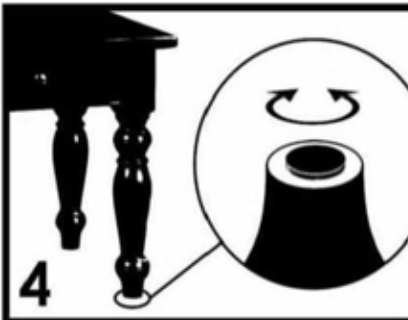

Some furniture comes with height adjustment knobs underneath each leg. To lower or to raise each leg, you need to turn clockwise or counterclockwise, respectively.

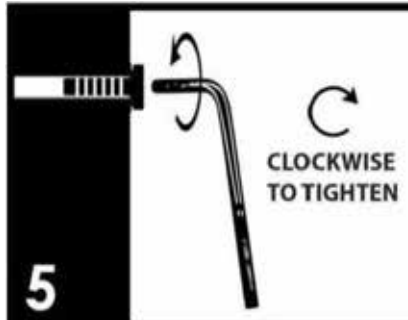

Make sure all parts are properly aligned, then use the appropriate hand tool to completely tighten the bolts or screws. Do not use power tools and do not overtighten.

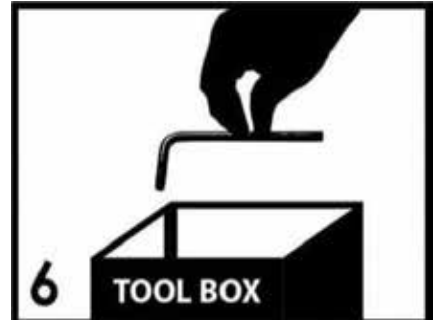

Save the instructions and store the Allen wrench or any supplied tool for later maintenance. After two weeks, check and tighten any loose hardware and repeat again every six months thereafter.

IT IS THE USER'S RESPONSIBILITY TO MAINTAIN THE FURNITURE. THE HARDWARE MAY LOOSEN OVER TIME AND MAY CAUSE THE FURNITURE TO BE WOBBLY AND UNABLE TO SUPPORT ITS INTENDED WEIGHT CAPACITY. THIS MAY LEAD TO COLLAPSE AND MAY CAUSE SERIOUS INJURY.

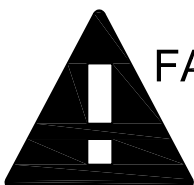

**FAILURE TO FOLLOW THE GUIDELINES ABOVE MAY RESULT IN INJURY AND/OR PROPERTY DAMAGE.**



Before you begin, please read Page 2 of "Assembly and Care Advice".

And remember, do not tighten until each step is completed or instructed.

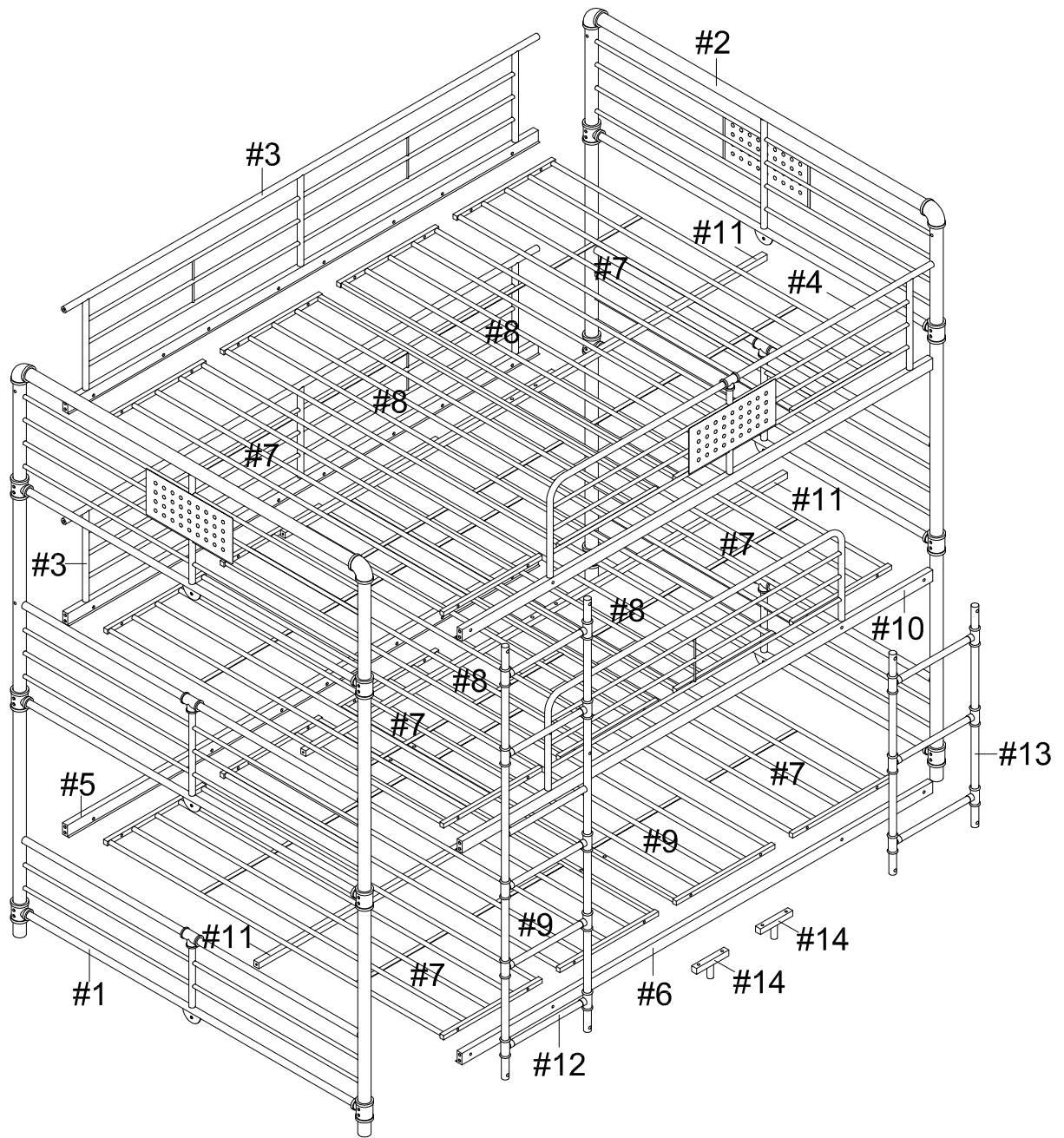



Before you begin, please read Page 2 of "Assembly and Care Advice".

And remember, do not tighten until each step is completed or instructed.

## Parts List

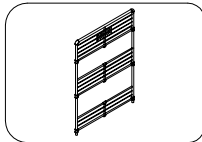

#1 x 1pc  
Left Headboard

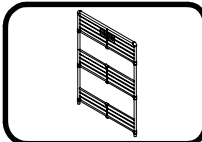

#2 x 1pc  
Right Headboard

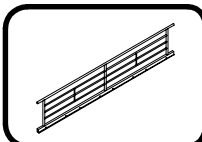

#3 x 2pcs  
Back Guardrail

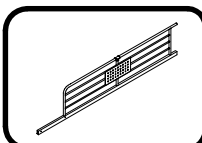

#4 x 1pc  
Front Upper Guardrail

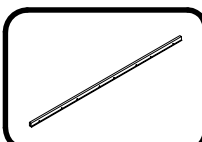

#5 x 1pc  
Rear Bed Frame Tube

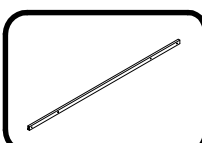

#6 x 1pc  
Front Bed Frame Tube

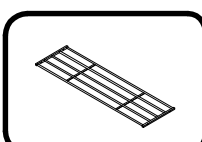

#7 x 6pcs  
End Bed Frame

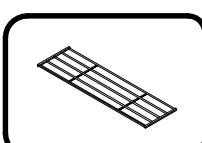

#8 x 4pcs  
Upper Middle Bed Frame

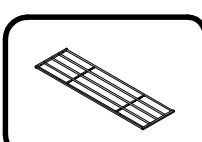

#9 x 2pcs  
Bottom Middle Bed Frame

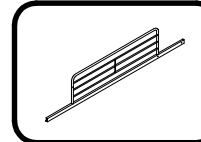

#10 x 1pc  
Front Lower Guardrail

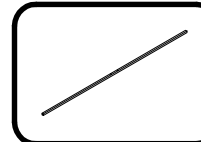

#11 x 3pcs  
Middle Support Tube

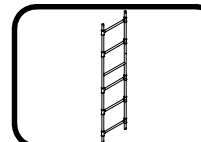

#12 x 1pc  
Long Ladder

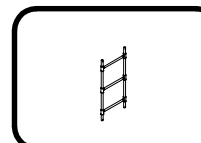

#13 x 1pc  
Short Ladder

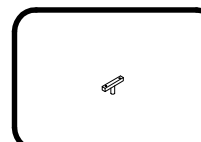

#14 x 2pcs  
Support Leg



Before you begin, please read Page 2 of "Assembly and Care Advice".

And remember, do not tighten until each step is completed or instructed.

## Hardware List



#A x 54pcs  
Bolt 1/4"x 1"



#B x 9pcs  
Bolt 1/4"x 1-3/8"



#C x 29pcs  
Bolt 1/4"x 3"

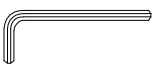

#D x 1pc  
Allen Wrench M4



#E x 2pcs  
Screw M4x37



#F x 4pcs  
Metal Plate



#G x 2pcs  
Bracket



#H x 2pcs  
Girding



#I x 10pcs  
Bolt 1/4"x 1-1/8"



1) Place both rear guardrails (#3) and rear tube (#5) flat on the ground, then align left/right headboards (#1,2) to the rear guardrails (#3) and rear tube (#5). Secure with bolts (#C).

#C x 29pcs  
#F x 2pcs

Make sure to screw in top part with plates (#F).

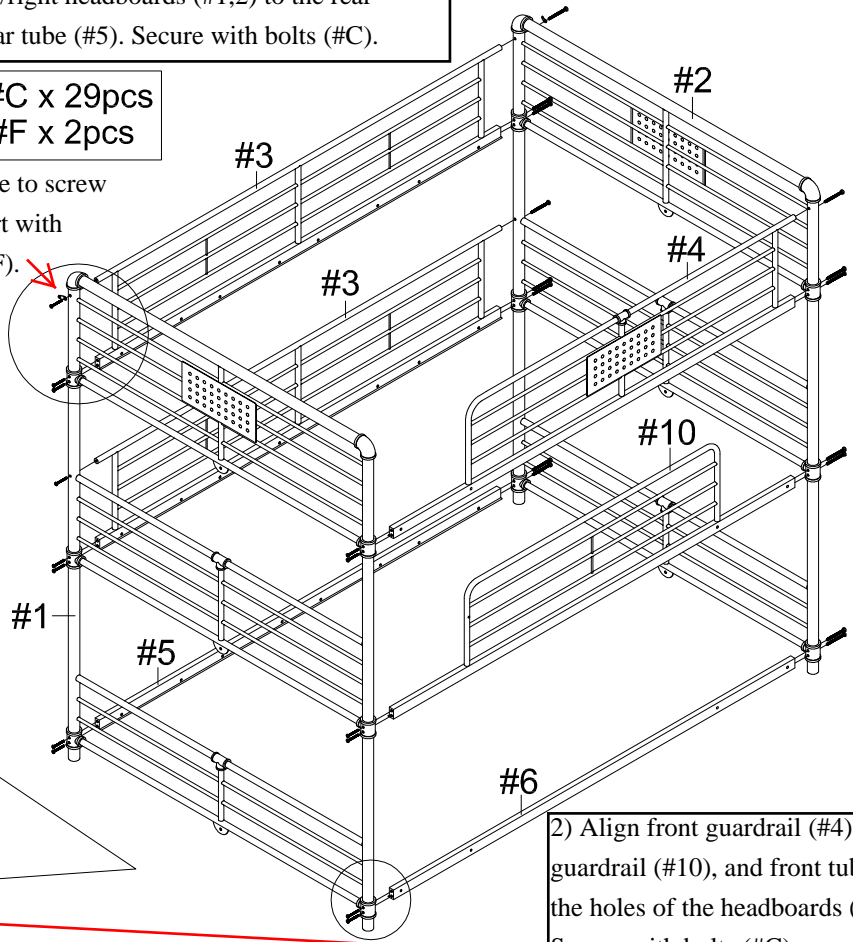
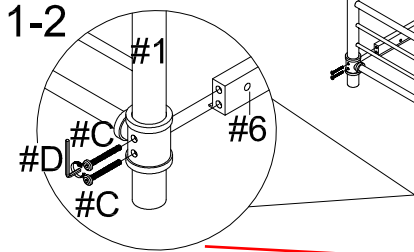
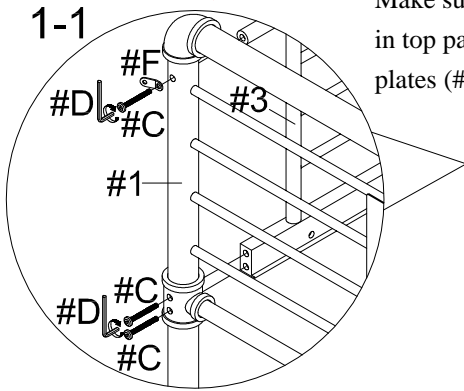

2) Align front guardrail (#4), middle guardrail (#10), and front tube (#6) to the holes of the headboards (#1,2). Secure with bolts (#C).



#A x 48pcs

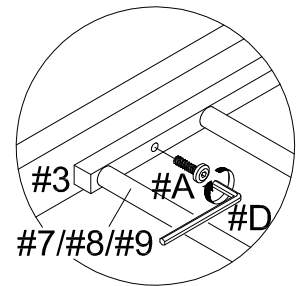
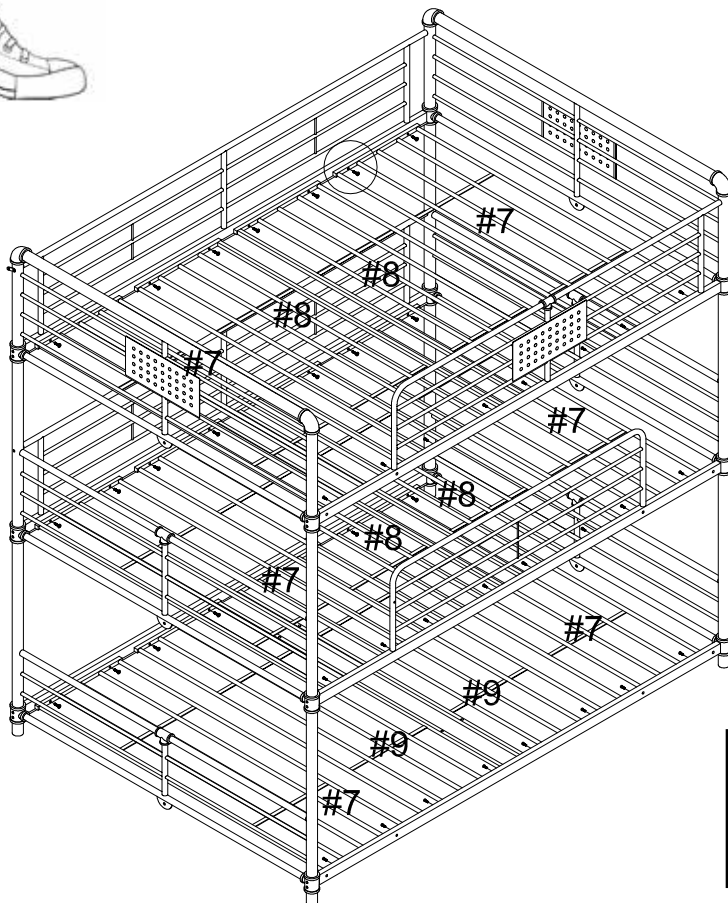

Align end bed frames (#7) to each end of the bunk beds. Secure with bolts (#A). Align middle bed frames (#8,9) to the middle holes of the bunk bed. Secure with bolts (#A).





#A x 6pcs  
#I x 10pcs

2) Secure bottom holes of the middle support tubes (#11) to the slats (#9) by using bolts (#I).

1) Align middle support tubes (#11) to the bottom end holes of each slats. Secure with bolts (#A).

3-1

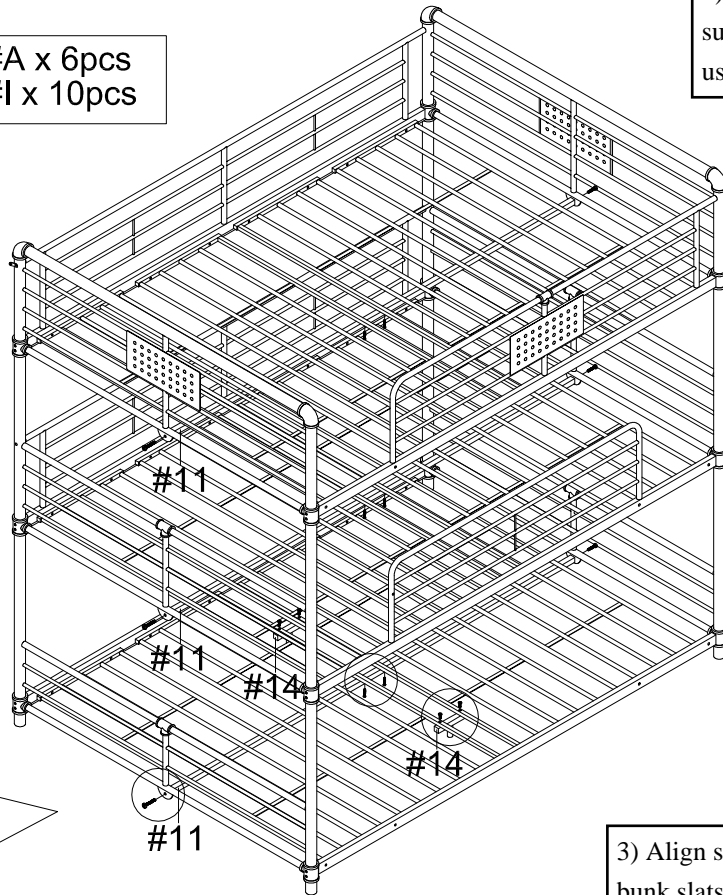
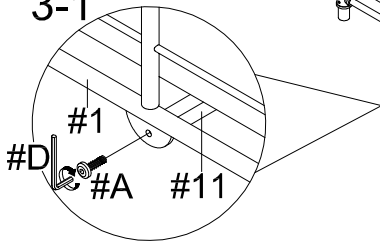

3-2

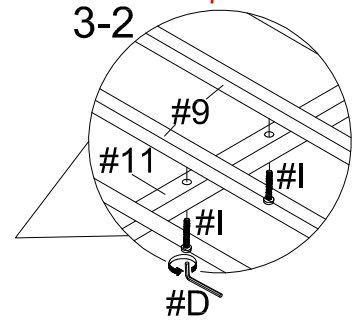

3-3

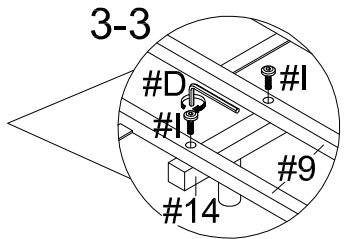

3) Align support legs (#14) to the bottom bunk slats (#9), then secure with bolts (#I).



#B x 9pcs

3) Align short ladder (#13) to the bunk bed. Secure with bolts (#B).

4-3

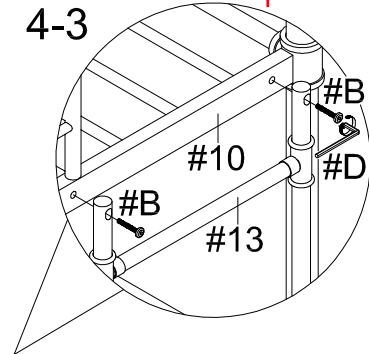

4-2

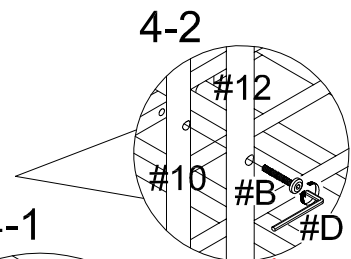

4-1

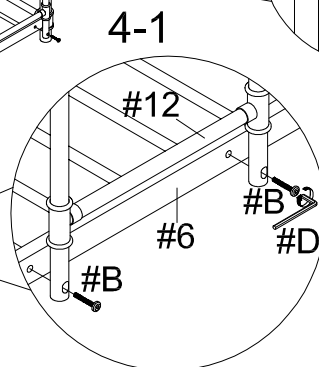

1,2) Align long ladder (#12) to the holes of the bunk bed. Secure with bolts (#B).

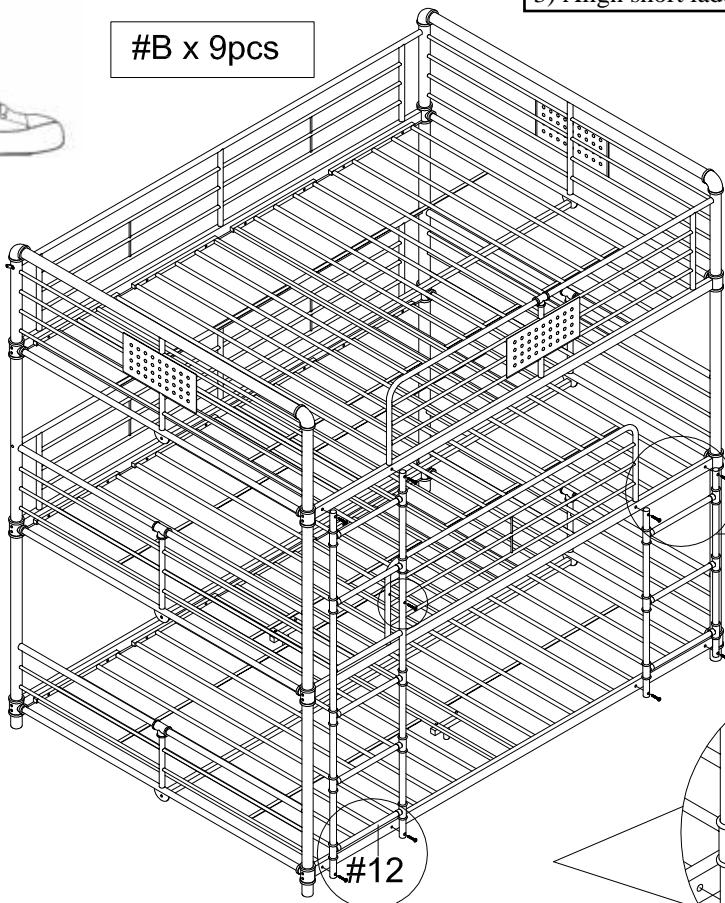

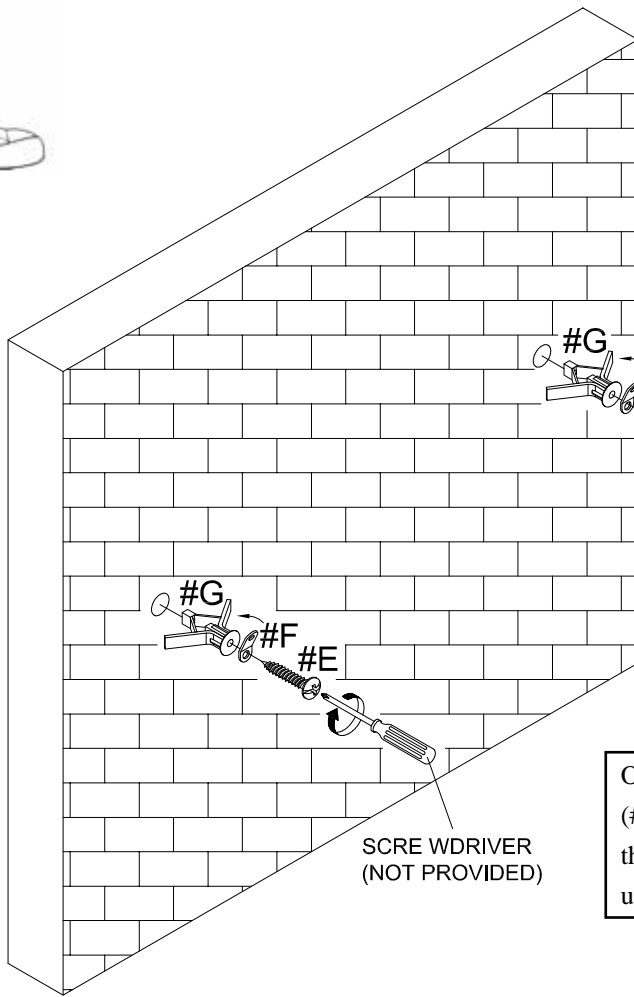

#E x 2pcs  
#F x 2pcs  
#G x 2pcs

SCRE WDRIVER  
(NOT PROVIDED)

SCRE WDRIVER  
(NOT PROVIDED)

OPTIONAL: Create hole on wall to fit the anchor (#G) in. Make sure the anchor is the same height as the bunk bed. Screw plates (#F) to the anchor (#G) using bolts (#E).

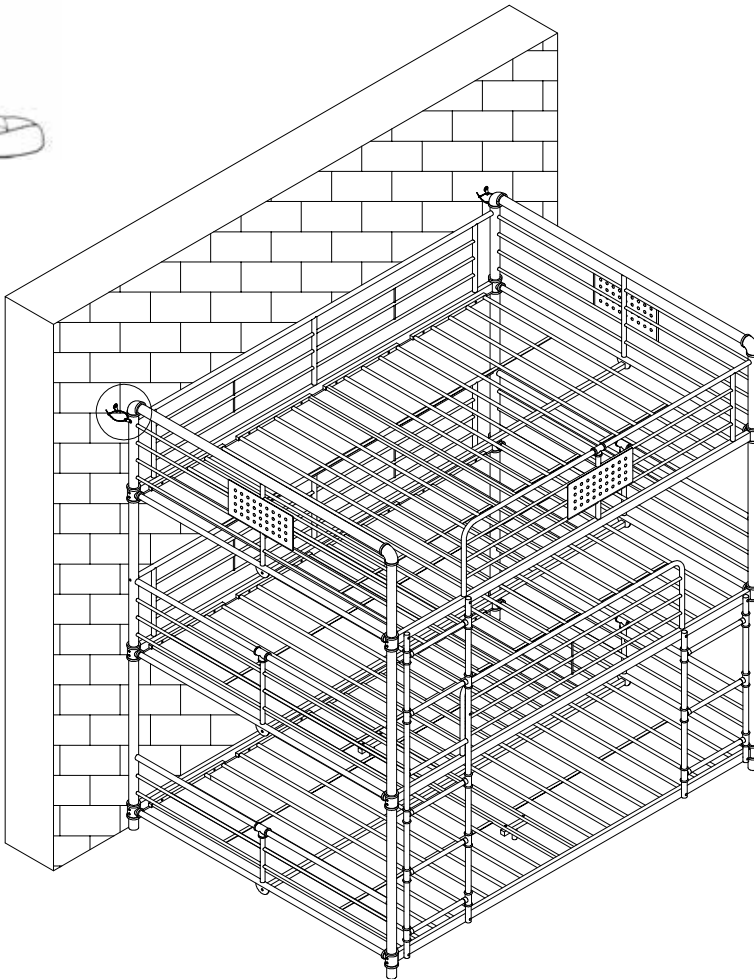

#H x 2pcs

To Prevent Tip over  
Product Must Be  
Attached To Wall

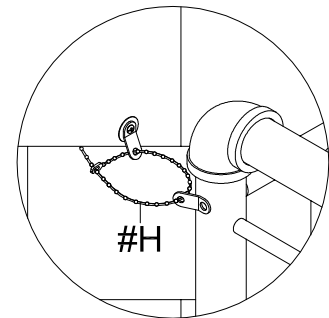

Align bunk bed to the anchor.  
Attach girding (#H) to the  
plates (#F).



## Safety Warnings

1. Follow the information on the warnings appearing on the upper bunk end structure and on the carton . Do not remove warning label from bed.
2. Always use the recommended size mattress or/and mattress support to help prevent the likelihood of entrapment or falls.
3. Surface of mattress must be at least 5 in. below the upper edge of guardrails .
4. Do not allow children less than 6 years of age to use the upper bunk.
5. Periodically check and ensure that the guardrail, ladder ,and other components are in their proper position ,free from damage ,and that all connectors are tight .
6. Prohibit horseplay on/or under the bed and prohibit jumping on the bed.
7. Always use the ladder for entering and leaving the upper bunk.
8. Do not use substitute parts ,Contact manufacturer or dealer for replacement parts.
9. Use of a night light may provide added safety precaution for a child using the upper bunk.
10. Always use guardrails on both long sides of the upper bunk.
11. If the bunk bed will be placed next to a wall, the guardrail that runs the full length of the bed should be placed against the wall to prevent entrapment between the bed and the wall.
12. The use of water or sleep flotation mattress is prohibited .
13. Keep these instructions for future reference.
14. Use only mattress which is 74 3/4"×54"×5" .
15. Prohibit more than one person on upper bunk.

### STRANGULATION HAZARD:

16. Never attach or hang items to any part of the bunk bed that are not designed for use with the bed for example, but not limited to hooks, belts, and jump ropes.