

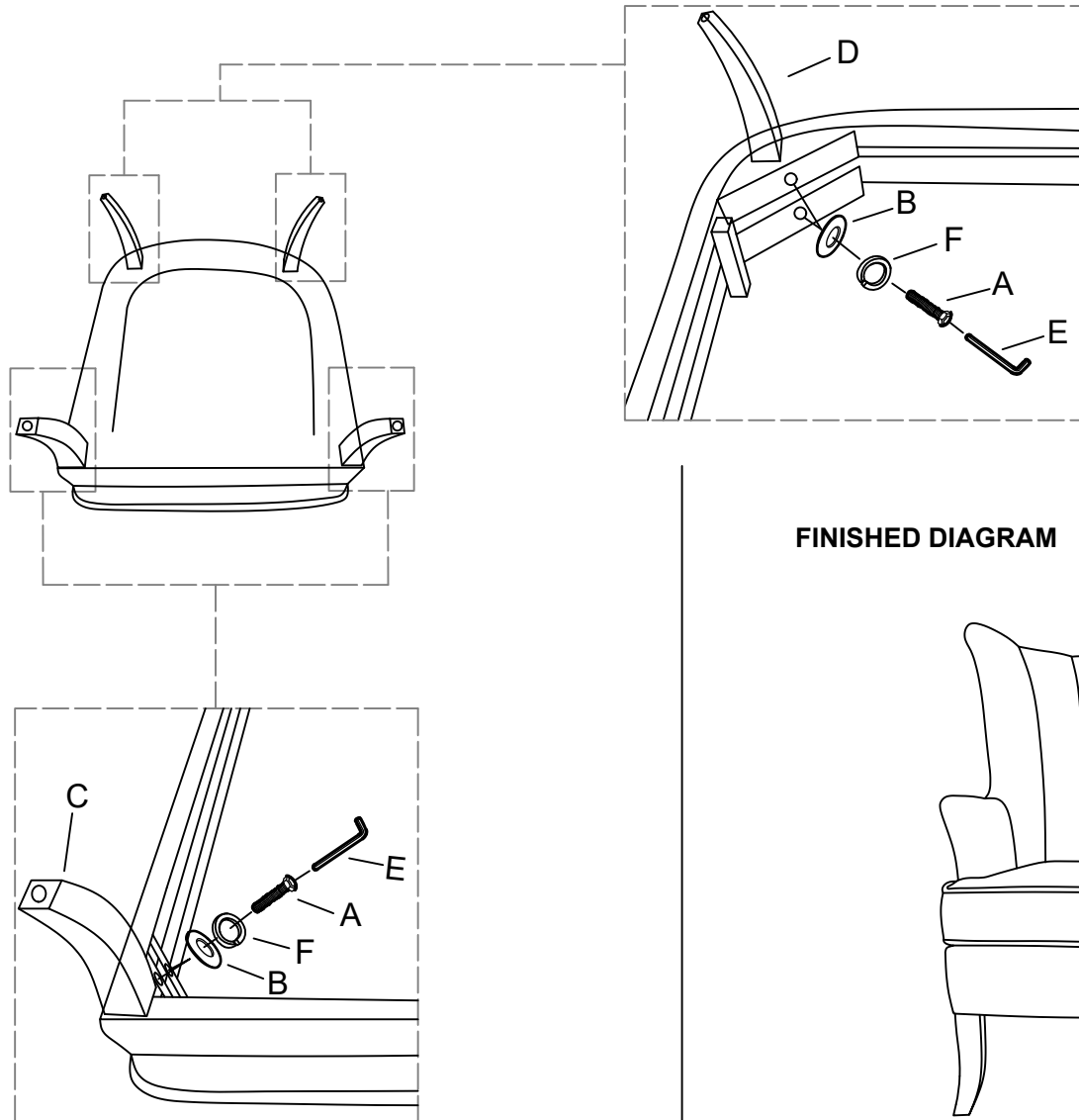





EVERLY CLUB CHAIR ASSEMBLY INSTRUCTIONS



HARDWARE LIST			
NO	Description	Qty	
A	 Bolt 8mm*60mm	8PCS	
B	 Flat Washer	8PCS	
C	 Front leg	2PCS	
D	 Rear leg	2PCS	
E	 Wrench	1PC	
F	 Spring Washer	8PCS	

FINISHED DIAGRAM

