

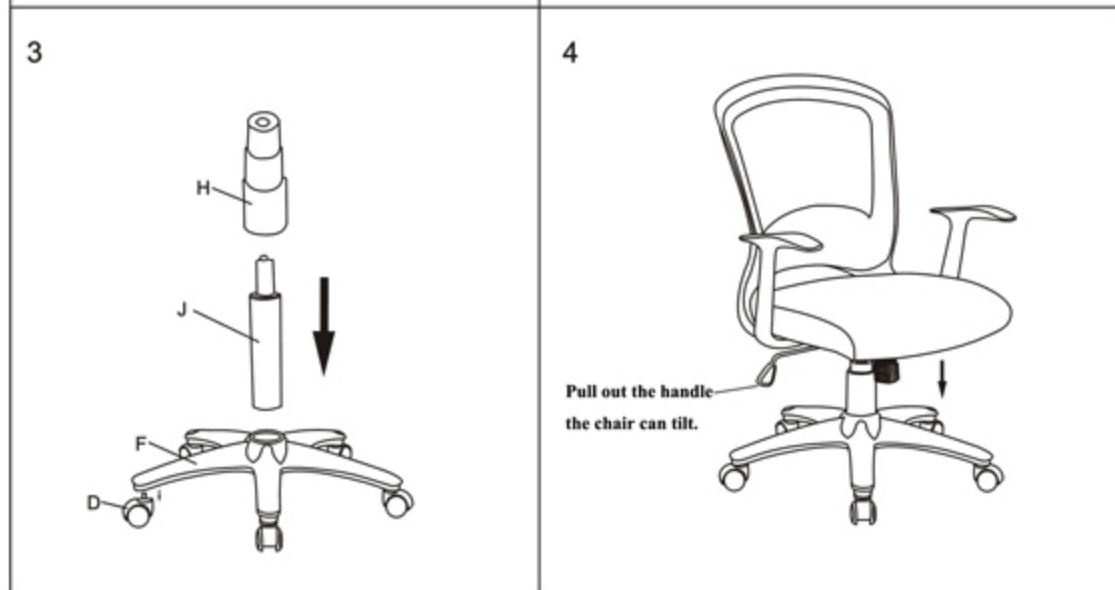

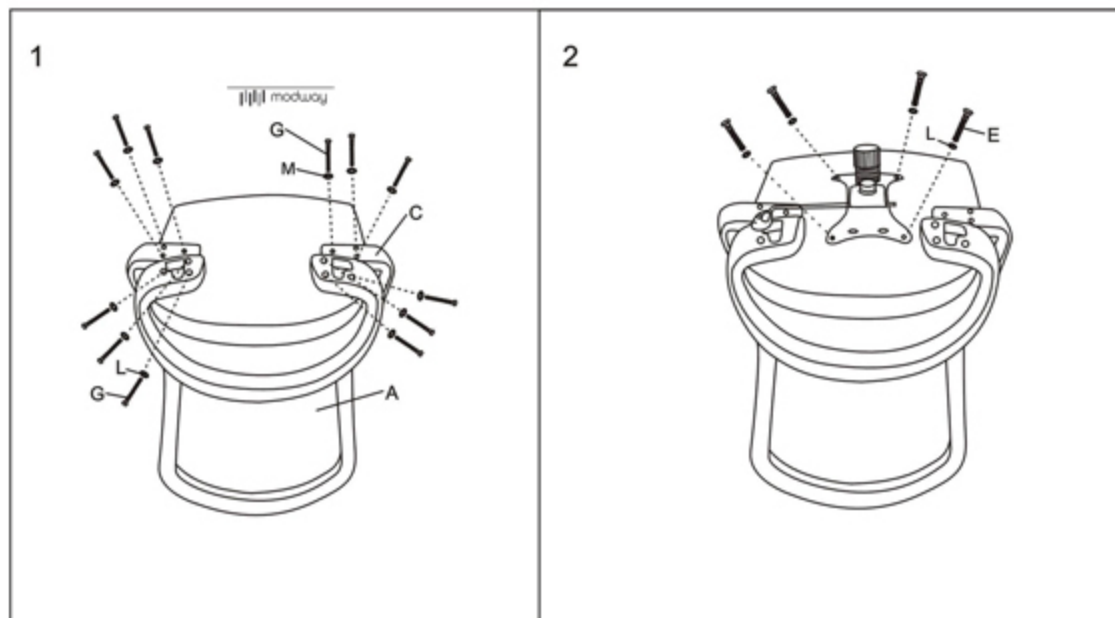











# Assembly Instruction

 modway

SKU: EEI-758/EEI-756

A		X1	B		X1
C		X2	D		X5
E	 M6X20MM	X4	F		X1
G	 M6X35MM	X12	H		X1
I		X1	J		X1
K		X1	L	 M6X18MM	X10
M	 M6X15MM	X6			