

ASSEMBLY INSTRUCTIONS

EEI-4633/ 5870

V1.03.05.22

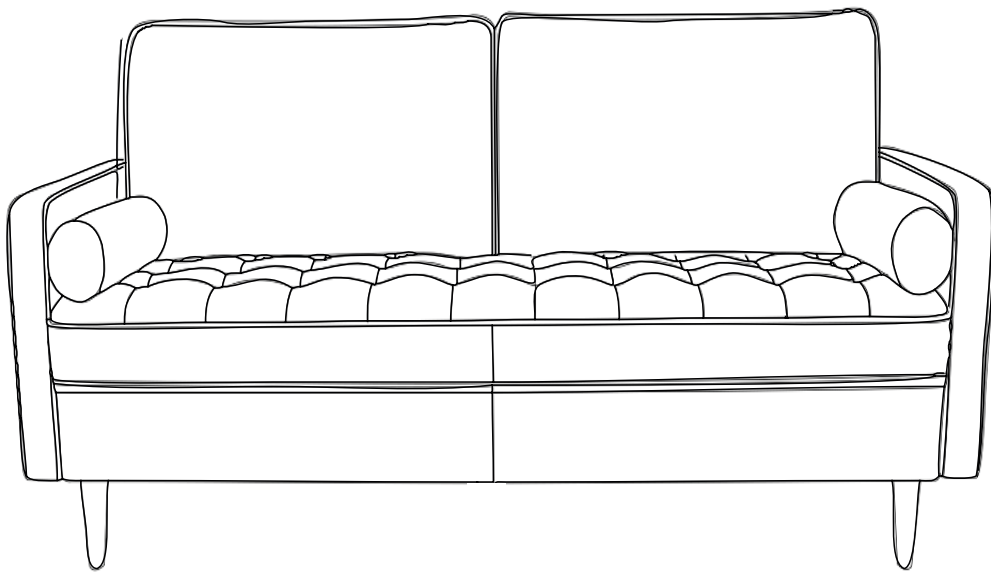

Questions? Contact us!

609.256.9000 • cs@modway.com
www.modway.com

*modway

Let's get started!

*modway



Read through all of the instructions before starting



Care instructions are listed in the last step of this manual



Approx. 30 minutes assembly time



Make sure you have all parts and components before discarding any packing materials



2 people recommended for assembly

Only use hand tools to assemble this item. Do not use power tools. Do not tighten bolts or screws completely until all hardware is lined up and inserted into the holes.

Do not over-tighten screws and bolts to avoid stripping the hardware or cracking the item.

Assemble your item on a flat, carpeted area, with plenty of space to work. This will prevent damage and scratches to your floors or the item while you're assembling the product.

Keep all components and packaging out of reach of children or animals to avoid risk of choking or suffocation.

Furniture components:

1	Sofa Seat	x1
2	Left Arm	x1
3	Right Arm	x1
4	Sofa Back	x1
5	Back Cushion Core	x2
6	Back Cushion Cover	x2
7	Pillow	x2
8	Front Legs	x2
9	Back Legs	x2

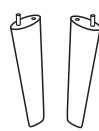
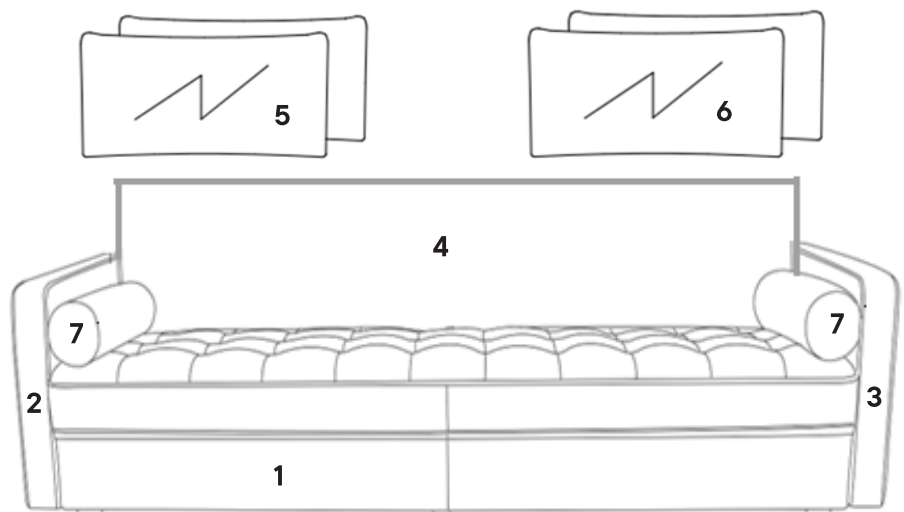

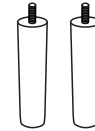

9



8

Provided hardware:

A	 Bolt M8 x 60mm	x2
B	 Flat Washer M8	x2
C	 Allen Wrench M5	x1

Wait!

Missing parts or hardware? Need assistance?
Contact us before returning your item. We're here to help!
609.256.9000 • cs@modway.com

Step 1

COMPONENTS

1	Sofa Seat	x1
5	Back Cushion Core	x2
6	Back Cushion Cover	x2
7	Pillow	x2
8	Front Legs	x2
9	Back Legs	x2

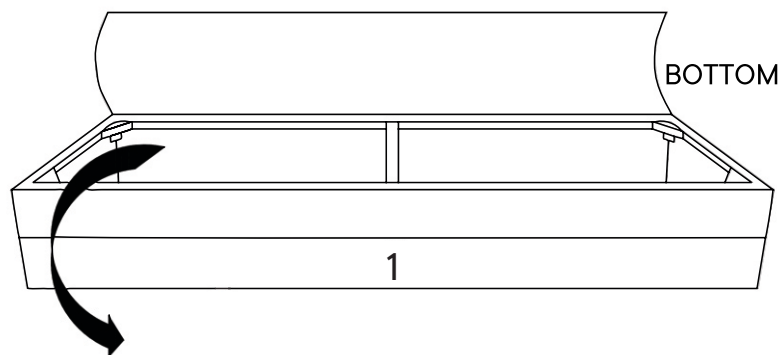

Unzip the bottom cover and locate the 2 Back Cushion Core(5) + 2 Back Cushion Cover (6) + 2 Pillows (7) + 2 Front Legs (8) + 2 Back Legs (9) + Hardware package.

Step 2

HARDWARE

A	Bolt M8 x 60mm	x2
B	Flat Washer M8	x2
C	Allen Wrench M5	x1

COMPONENTS

1	Sofa Seat	x1
8	Front Legs	x2
9	Back Legs	x2

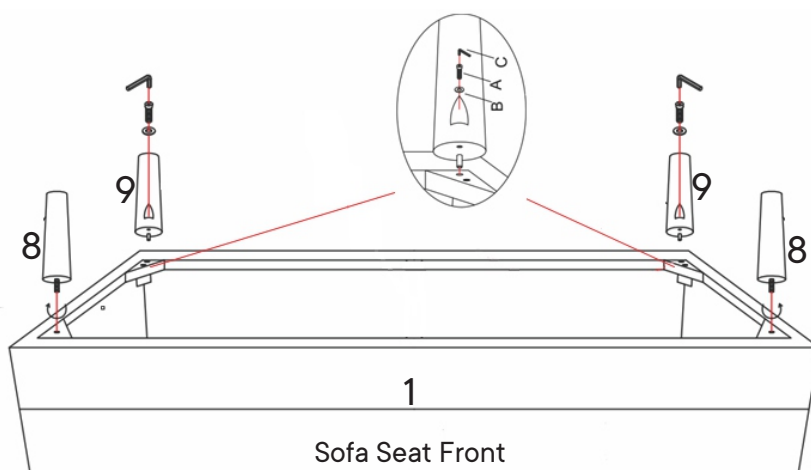

Step 3

COMPONENTS

- | | | |
|---|-----------|----|
| 1 | Sofa Seat | x1 |
| 2 | Left Arm | x1 |
| 3 | Right Arm | x1 |

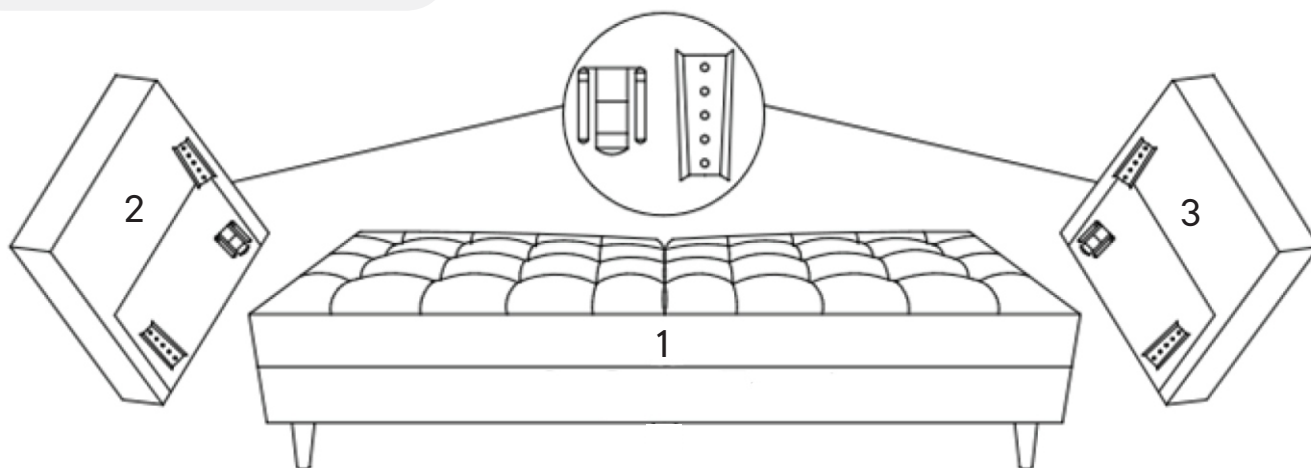

Step 4

COMPONENTS

- | | | |
|---|-----------|----|
| 1 | Sofa Seat | x1 |
| 2 | Left Arm | x1 |
| 3 | Right Arm | x1 |
| 4 | Sofa Back | x1 |

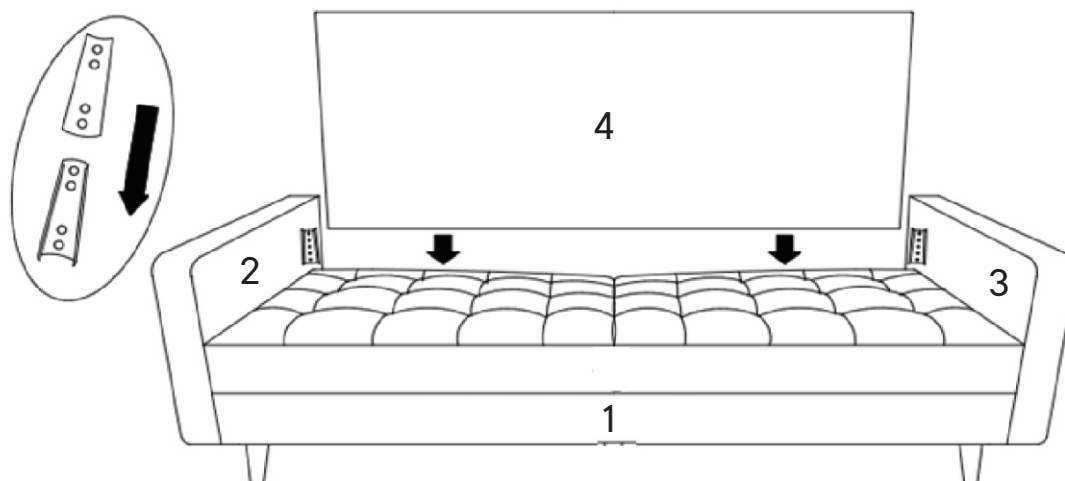

Step 5

COMPONENTS

- 5 Back Cushion Core x2
- 6 Back Cushion Cover x2

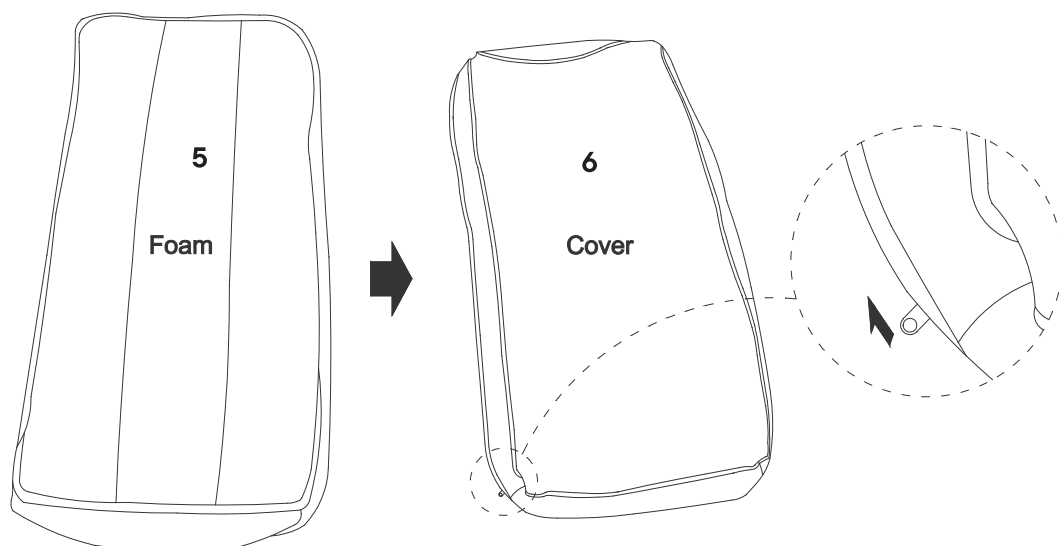

Step 6

COMPONENTS

- 6 Back Cushion x2

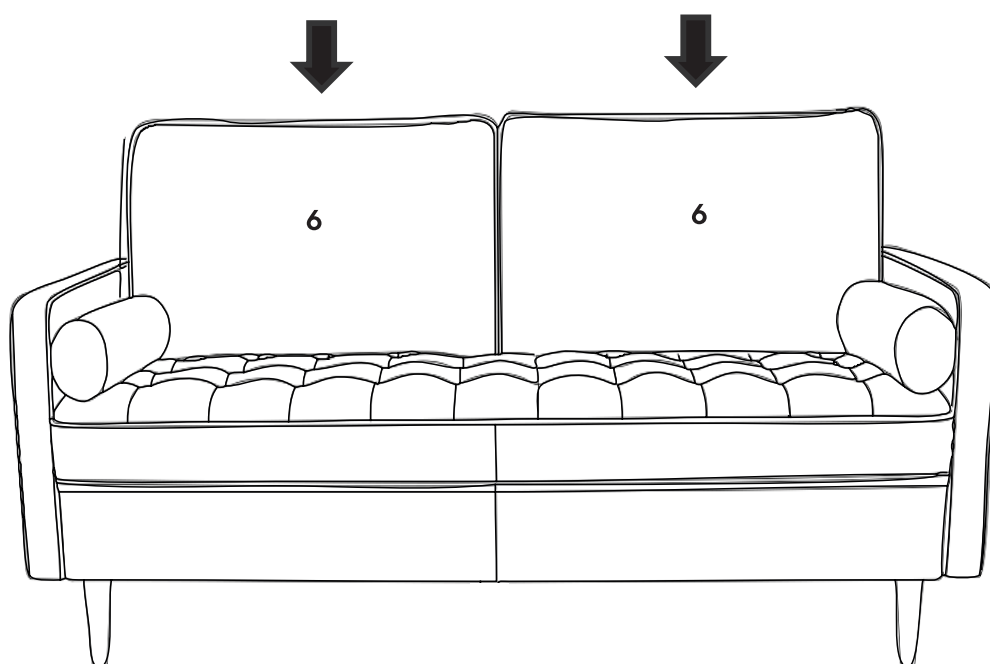

Great job!

Your love seat / apartment sofa is complete.

♥ CARING FOR YOUR ITEM

Indoor use only.

Not contract grade.

Clean using a non-abrasive cloth and a mild cleaner.

Never use harsh chemicals, as they could damage the finish or integrity of the item.

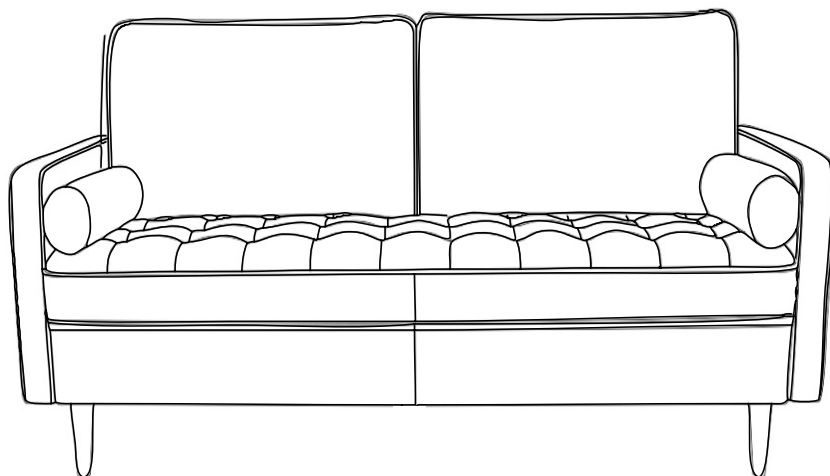

CONNECT WITH US!   

Tag us [@modway_furniture](#) and [#modway](#) for a chance to be featured.