

# ASSEMBLY INSTRUCTIONS

# EEI-5618

V1.05.25.21

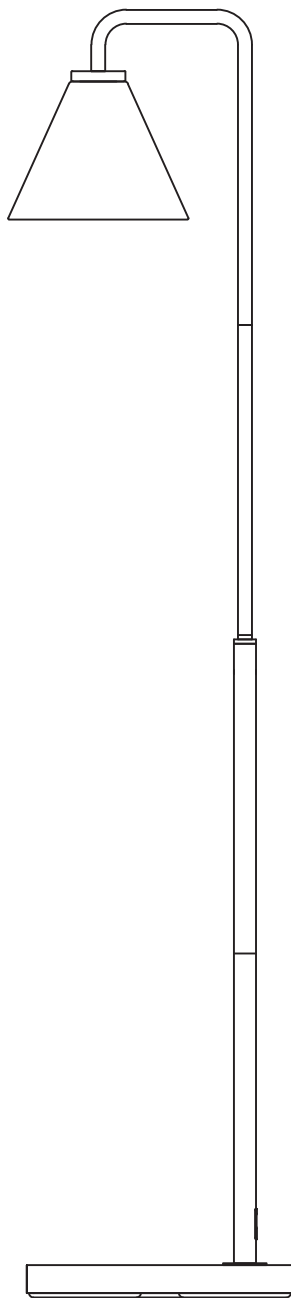

## Questions? Contact us!

609.256.9000 • [cs@modway.com](mailto:cs@modway.com)  
[www.modway.com](http://www.modway.com)

\*modway

# Let's get started!



Read through all of the instructions before starting

Do not over-tighten screws and bolts to avoid stripping the hardware or cracking the item.

Check all parts and hardware for damage. If the product is damaged, it should not be used.



Make sure you have all parts and components before discarding any packing materials







Assemble your item on a flat, carpeted area, with plenty of space to work. This will prevent damage and scratches to your floors or the item while you're assembling the product.

We recommend LED bulbs. LEDs are better for energy consumption and can prolong the life of the fixture.

Keep all components and packaging out of reach of children or animals to avoid risk of choking or suffocation.

Allow the fixture to cool before changing the bulb. Fixture may get hot when in use.

## Provided hardware:

A		Lamp Socket Ring	x1	D		Lamp Socket Cup	x1
B		Plum Washer	x1	E		Screw Nut	x1
C		Washer	x1	F		Wrench	x1



### CARING FOR YOUR ITEM

Indoor use only.

Clean using a non-abrasive cloth and a mild cleaner.

Never use harsh chemicals, as they could damage the finish or integrity of the item.

## What you need:

One (1) E26 (medium-base) Light Bulb (MAX. 60W)  
Bulb not included

Wait!

Missing parts or hardware? Need assistance?

Contact us before returning your item. We're here to help!  
609.256.9000 • [cs@modway.com](mailto:cs@modway.com)

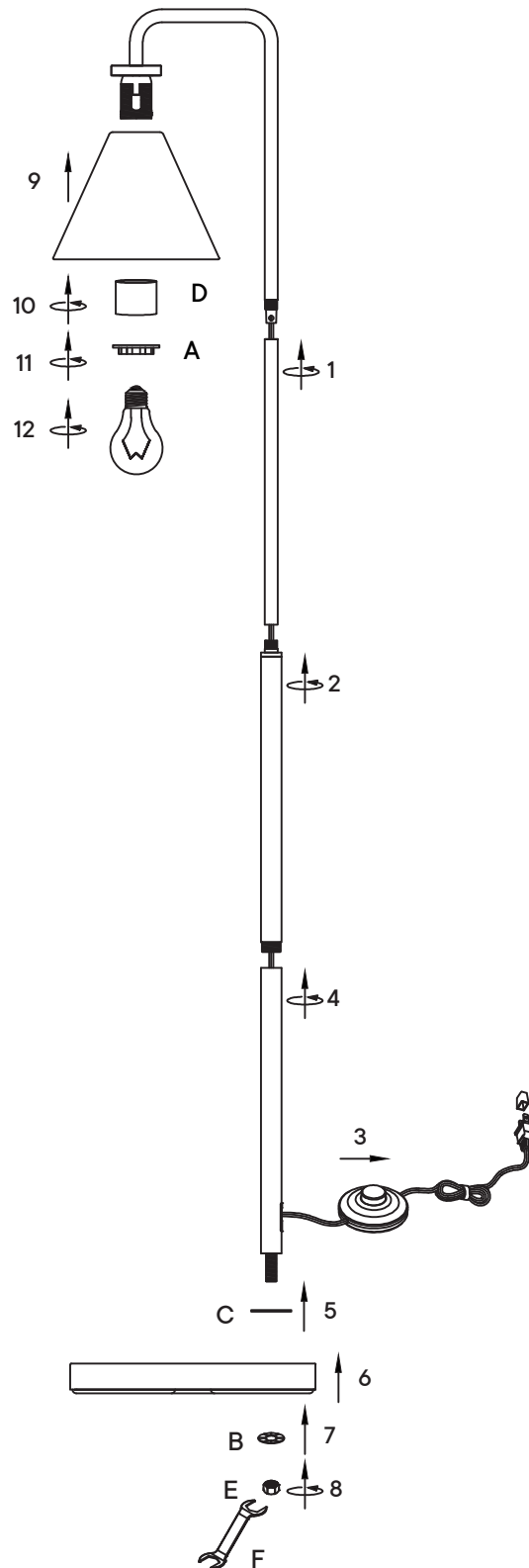

**ATTENTION:** To avoid the risk of fire, do not exceed the recommended wattage indicated on the wattage label.

CONNECT WITH US!   

Tag us @modway\_furniture and #modway for a chance to be featured.