

ASSEMBLY INSTRUCTIONS

EEI-5309

V1.03.22.21

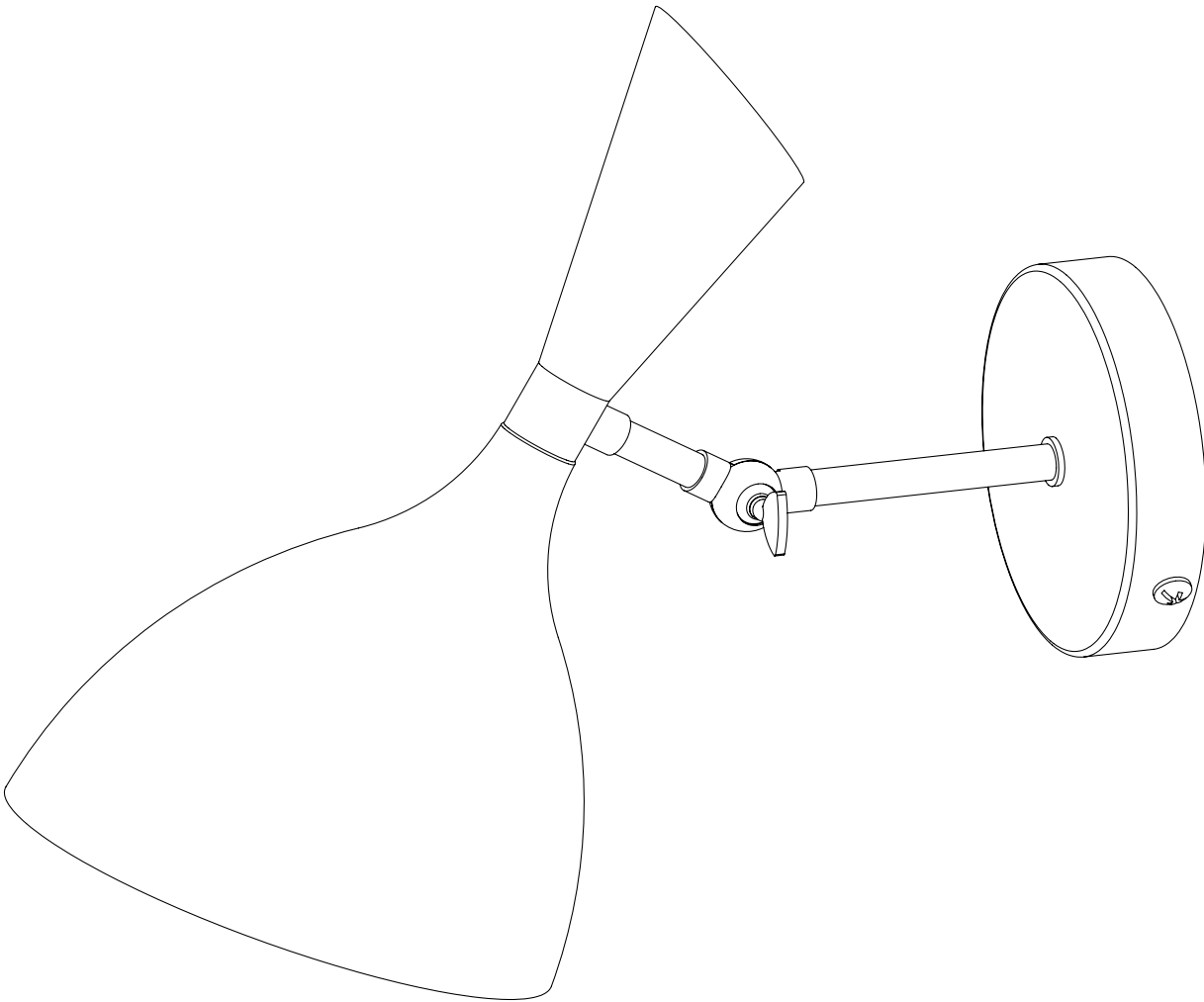

Questions? Contact us!





609.256.9000 • cs@modway.com
www.modway.com

*modway

Let's get started!

*modway

Hardware included in the box:

A		Mounting Plate	x1
B		Long Screw	x2
C		Wire Caps	x3
D		Short Green Screw	x1
E		Side Screw	x2

What you need:

1		Phillips Head Screwdriver
---	---	---------------------------

You may also need:

- + Ladder
- + Electrical Tape
- + Wire Strippers or Cutters
- + Power Drill
- + One (1) E26 (medium-base) Light Bulb (MAX. 60W)



Missing parts or hardware? Need assistance?

Contact us before returning your item.

We're here to help!

609.256.9000 • cs@modway.com

CONNECT WITH US!



Tag us @modway_furniture and #modway for a chance to be featured.

Before you begin, here are some things to keep in mind:

Read through all of the instructions before starting. Make sure you have all parts and components before discarding any packing materials.

For hardwiring installation, we suggest hiring a professional electrician.

Do not over-tighten screws and bolts to avoid stripping the hardware or cracking the item.

Assemble your item on a flat, carpeted area, with plenty of space to work. This will prevent damage and scratches to your floors or the item while you're assembling the product.

Keep all components and packaging out of reach of children or animals to avoid risk of choking or suffocation.

Check all parts and hardware for damage. If the product is damaged, it should not be used.

We recommend LED bulbs. LEDs are better for energy consumption and can prolong the life of the fixture.

Installation and electrical connections must follow local and National Electric Code standards.

Ensure the main power supply is OFF before starting work to prevent electrical shock.

Allow the fixture to cool before changing the bulb. Fixture may get hot when in use.

CARING FOR YOUR ITEM

Indoor use only.

Clean using a non-abrasive cloth and a mild cleaner.

Never use harsh chemicals, as they could damage the finish or integrity of the item.

*modway

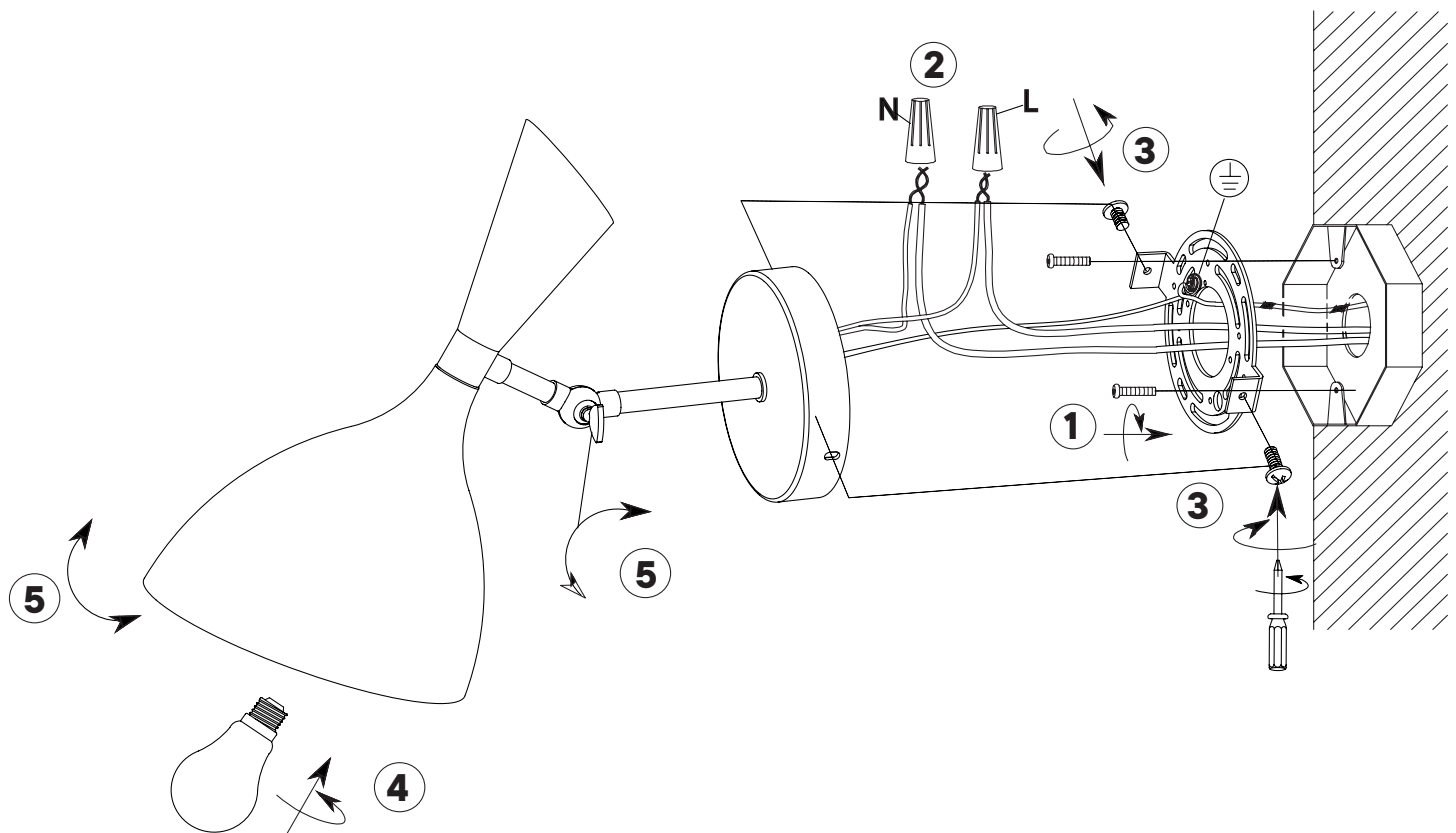

Step 1 Attach the **Mounting Plate (A)** to the junction box in the wall and affix it with **2 Long Screws (B)**.

Step 2 Connect wires with matching polarity. The black fixture wire connects to the black supply wire (live wire) and the white fixture wire to the white supply wire (neutral wire). Secure each connection using a **Wire Cap (C)**. Connect the copper fixture wire to the ground wire and secure the connection with a **Wire Cap (C)**. If there is not a supply ground wire, attach the copper fixture wire to the **Short Green Screw (D)** to ground.

Step 3 Attach the wall base to the **Mounting Plate (A)** and secure it with **2 Side Screws (E)**.

Step 4 Install the light bulb according to the wattage label (E26, MAX. 60W, bulb not included)

Step 5 The lamp shade can be adjusted to the desired position using the knob.

ATTENTION: When installing, we suggest hiring a professional electrician. To avoid the risk of fire, do not exceed the recommended wattage indicated on the wattage label.