

ASSEMBLY INSTRUCTIONS

EEI-5008

V1.09.28.21

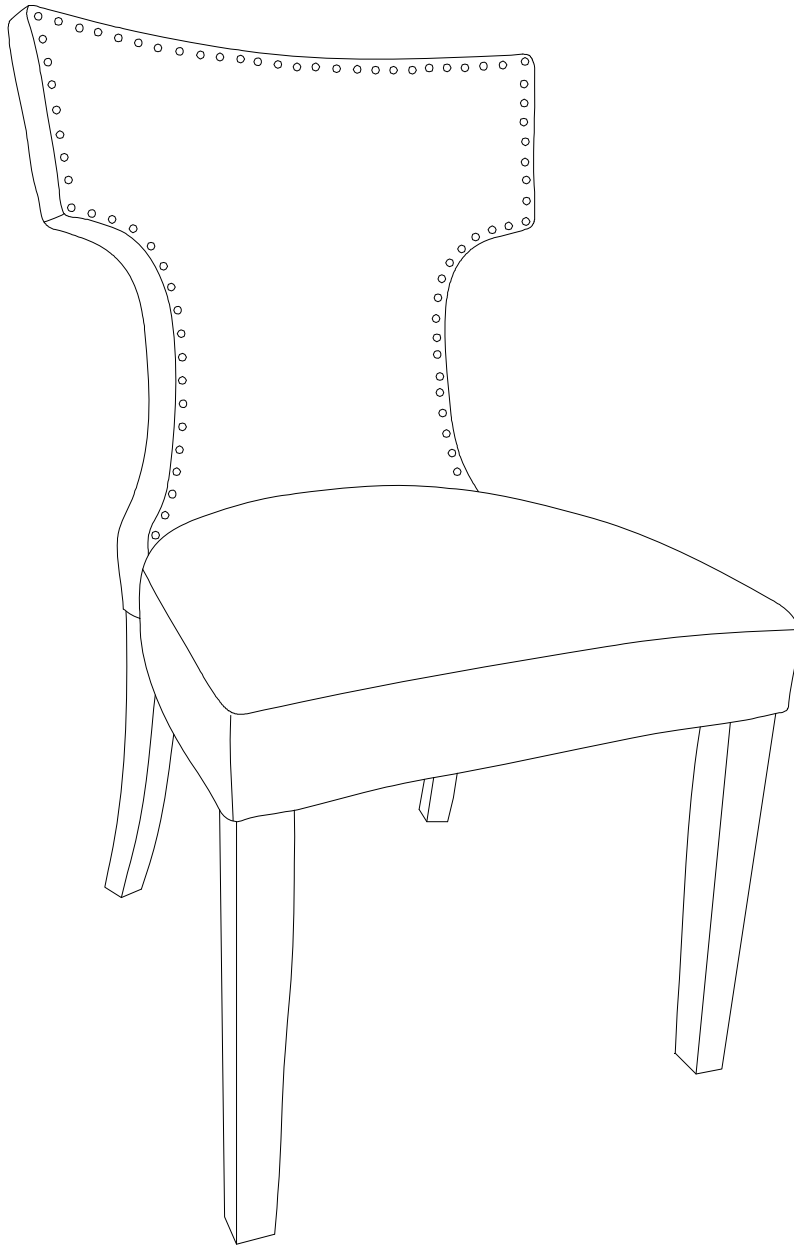

Questions? Contact us!

609.256.9000 • cs@modway.com
www.modway.com

***modway**

Let's get started!

*modway



Read through all of the instructions before starting



Care instructions are listed in the last step of this manual



Approx. 30 minutes assembly time



Make sure you have all parts and components before discarding any packing materials



2 people recommended for assembly

Only use hand tools to assemble this item. Do not use power tools. Do not tighten bolts or screws completely until all hardware is lined up and inserted into the holes.

Do not over-tighten screws and bolts to avoid stripping the hardware or cracking the item.





Assemble your item on a flat, carpeted area, with plenty of space to work. This will prevent damage and scratches to your floors or the item while you're assembling the product.

Keep all components and packaging out of reach of children or animals to avoid risk of choking or suffocation.

Furniture components:

1	Chair Back	x1
2	Chair Seat & Frame	x1
3	Front Legs	x2

Provided hardware:

A		Bolt M8x57mm	x5
B		Bolt M8x90mm	x4
C		Spring Washer M8	x9
D		Flat Washer M8	x9
E		Allen Key	x1

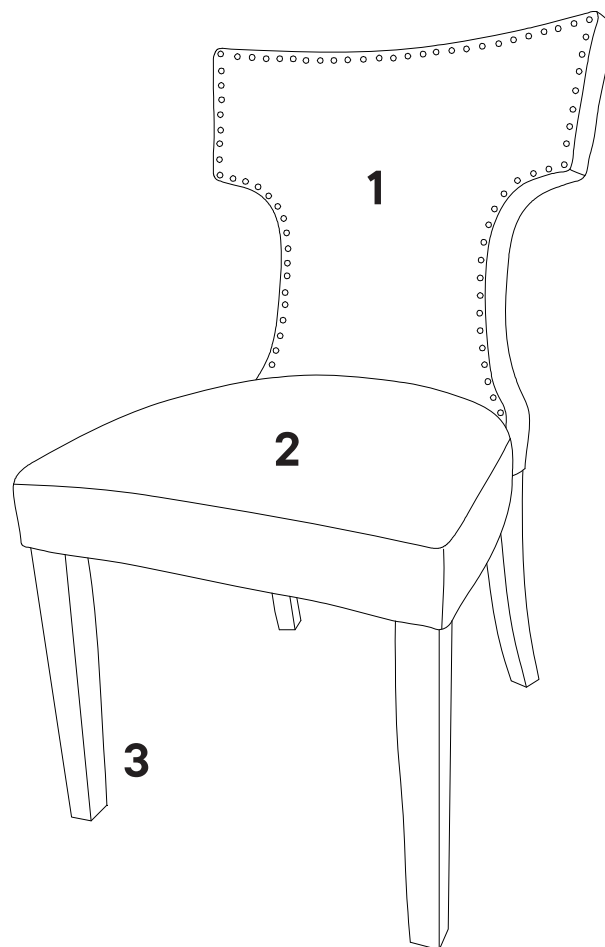

Wait!

Missing parts or hardware? Need assistance?

Contact us before returning your item. We're here to help!
609.256.9000 • cs@modway.com

Step 1

HARDWARE

A	Bolt M8x57mm	x1
C	Spring Washer M8	x1
D	Flat Washer M8	x1
E	Allen Key	x1

COMPONENTS

1	Chair Back	x1
2	Chair Seat & Frame	x1

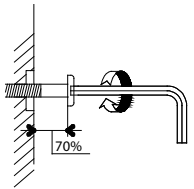
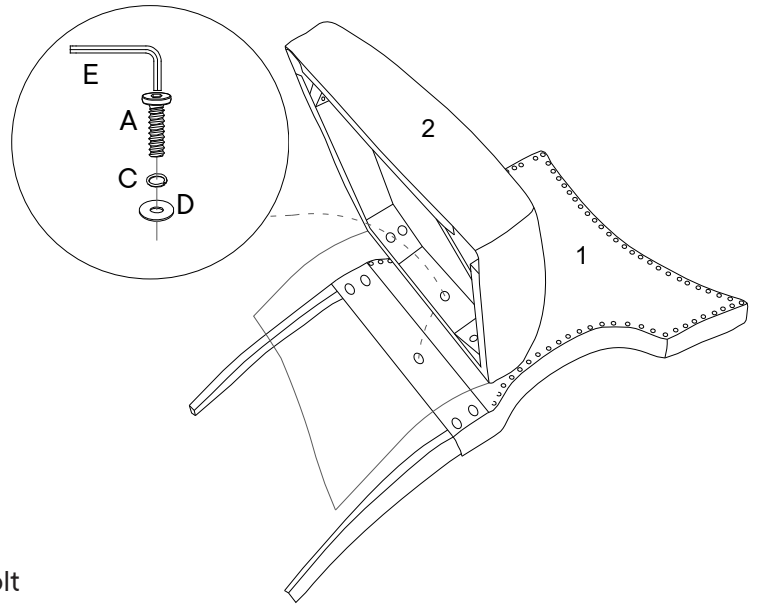

NOTE : Do not fully tighten the bolt

Step 2

HARDWARE

B	Bolt M8x90mm	x4
C	Spring Washer M8	x4
D	Flat Washer M8	x4
E	Allen Key	x1

COMPONENTS

1	Chair Back	x1
2	Chair Seat & Frame	x1

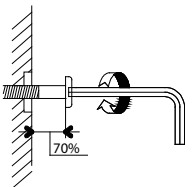
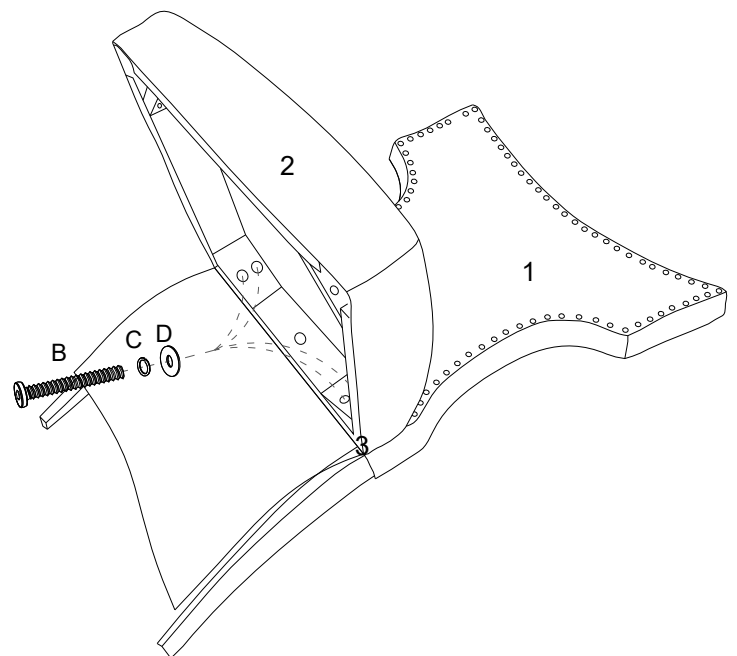

NOTE : Do not fully tighten the bolt

Step 3

HARDWARE

- A** Bolt M8x57mm x4
- C** Spring Washer M8 x4
- D** Flat Washer M8 x4
- E** Allen Key x1

COMPONENTS

- 1** Chair Back x1
- 2** Chair Seat & Frame x1
- 3** Front Legs x2

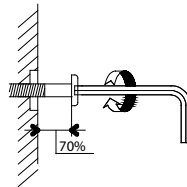
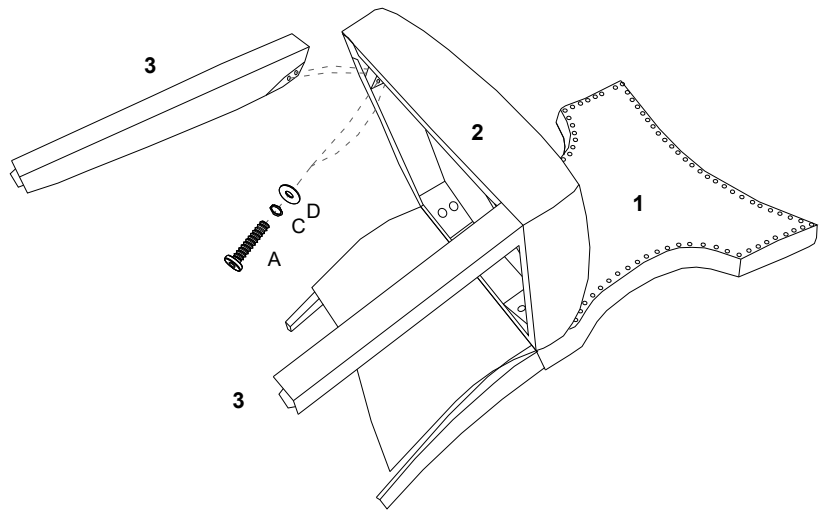

NOTE : Do not fully tighten the bolt

Step 4

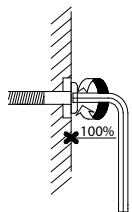
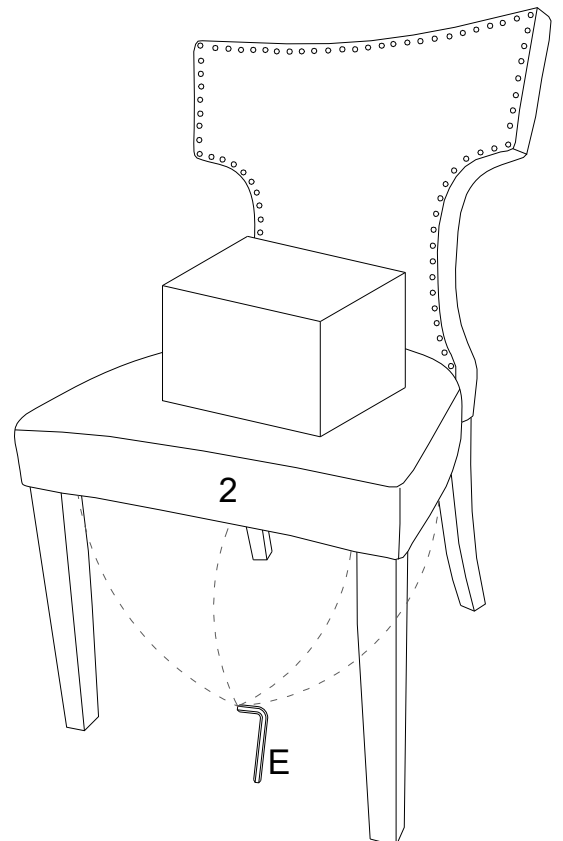

NOTE : To assist with leveling the chair, place a heavy object or have an adult sit on the Chair Seat (2) to pressure the chair for leveling and fully tighten all bolts with Allen Key (E) to secure all legs.

Great job!

Your chair is complete and ready to enjoy.

♥ CARING FOR YOUR ITEM

Indoor use only.

Not contract grade.

Spot clean using a non-abrasive cloth and a mild cleaner.

Never use harsh chemicals, as they could damage the finish or integrity of the item.

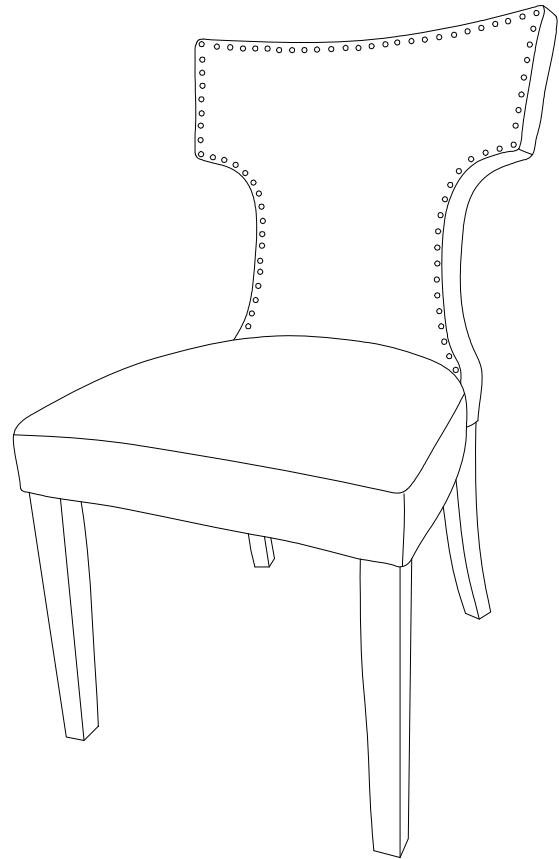

CONNECT WITH US!   

Tag us @modway_furniture and #modway for a chance to be featured.