

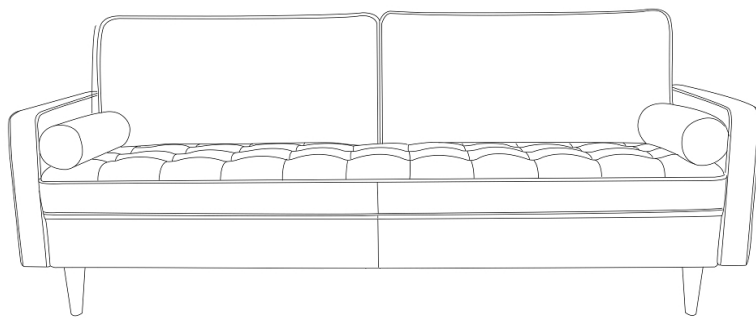

Thank you for purchasing the **MODWAY Loveseat**.

Before you start, here are some helpful advice:

1. We suggest you spend a short time reading through this leaflet and then follow the simple step-by-step instructions.
2. Owing to the size and weight of the loveseat, we recommend that it is assembled by two adults, on a carpeted or padded area, in the room that it is intended for. Approximate assembly time: 30 minutes.
3. Please do not use any tools other than those provided or recommended in these instructions.
4. Please do not throw away any of the packaging or the instruction until you have checked all the components and hardware and the furniture is fully assembled. Please ensure that the packaging is disposed of in a safe and environmentally friendly way.
5. Assemble all components loosely until advised to tighten. Depending on use, it may be necessary to tighten the components from time to time, so please save the tools that have been provided.
6. Please keep all pieces out of reach of children.



- A.  Bolt M8x60mm x2
- B.  Flat Washer M8 x2
- C.  Allen Wrench M5 x1

Components:

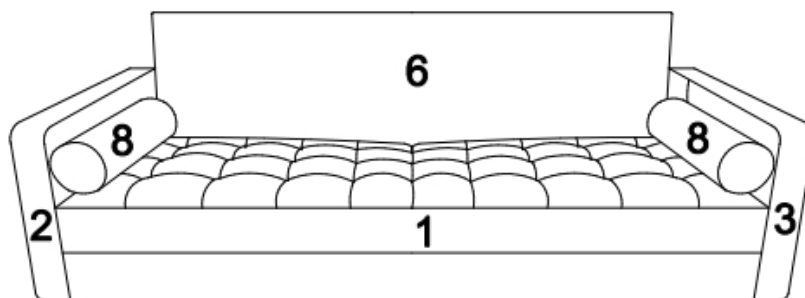
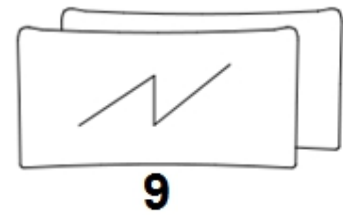
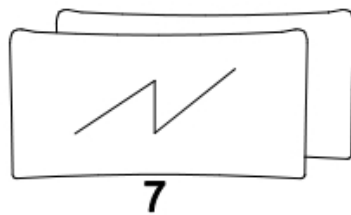

- | | | | | | | | |
|-----------------------|----|--------------|----|----------------------|----|--------------|----|
| 1. Sofa Seat | x1 | 2. Left Arm | x1 | 3. Right Arm | x1 | 4. Front Leg | x2 |
| 5. Back Leg | x2 | 6. Sofa Back | x1 | 7. Back Cushion Core | x2 | 8. Pillow | x2 |
| 9. Back Cushion Cover | x2 | | | | | | |

STEP 1:

1. Please put the **Sofa Seat (1)** upside down on a carpeted or padded area by two adults.
2. Open the Zipper at the bottom of **Sofa Seat (1)** and take out the 2 pieces of **Front Legs (4)**, 2 pieces of **Back Legs (5)**, 2 pieces of **Back Cushion Cores (7)**, 2 pieces of **Pillows (8)**, **Left Arm (2)**, **Right Arm (3)** and **hardware bag**.

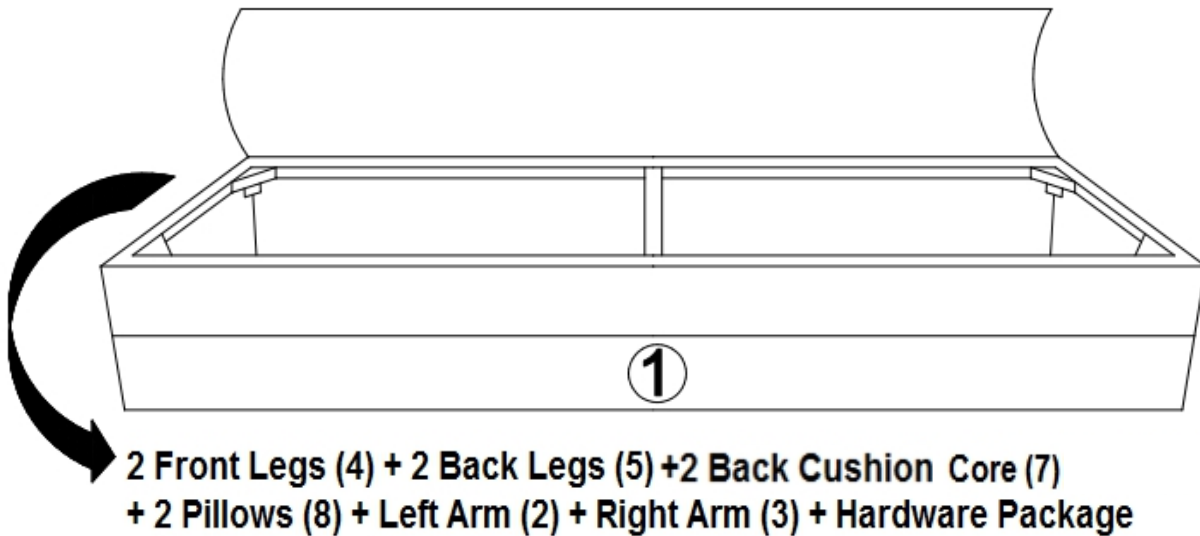

STEP 2:

1. Tighten 2 pieces of **Front Legs (4)** to the front bottom of the **Sofa Seat (1)** clockwise as shown by hand.
2. Attach 2 pieces of **Back Legs (5)** to the **Sofa Seat (1)** by using 2 pieces of **Bolts (A)** and 2 pieces of **Flat Washer (B)** as shown with Figure . Use **Allen Wrench (C)** to tighten all **Bolts (A)**.

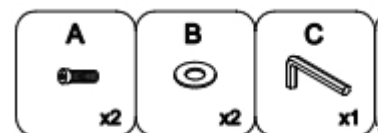
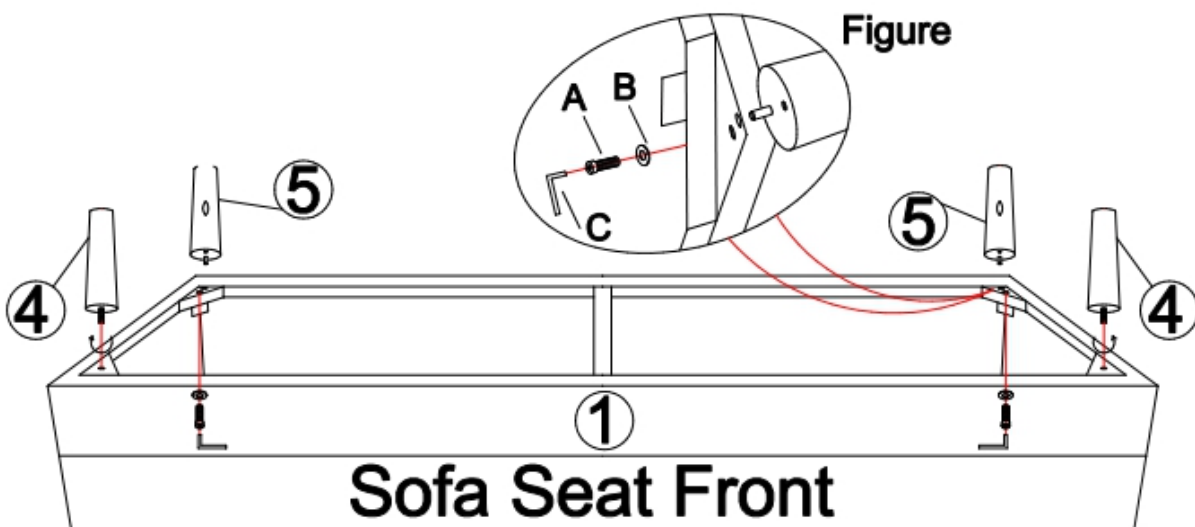

Hardware & Tools Required

STEP 3:

1. Please carefully turn over **Sofa Seat (1)**.
2. Insert **Left Arm (2)** and **Right Arm (3)** to **Sofa Seat (1)** by using the pre-installed Clips on **Sofa Seat (1)**, **Left Arm (2)** and **Right Arm (3)** to lock each other as shown.

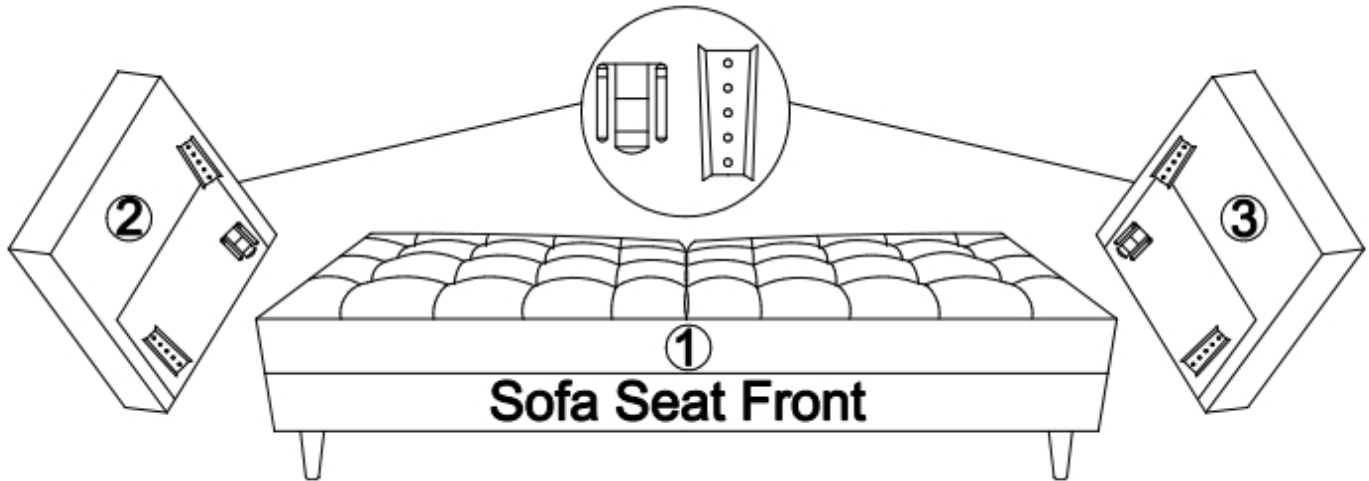

STEP 4:

- Insert **Sofa Back (6)** to **Left Arm (2)** and **Right Arm (3)** by using the pre-installed Clips on **Left Arm (2)**, **Right Arm (3)** and **Sofa Back (6)** to lock each other as shown.

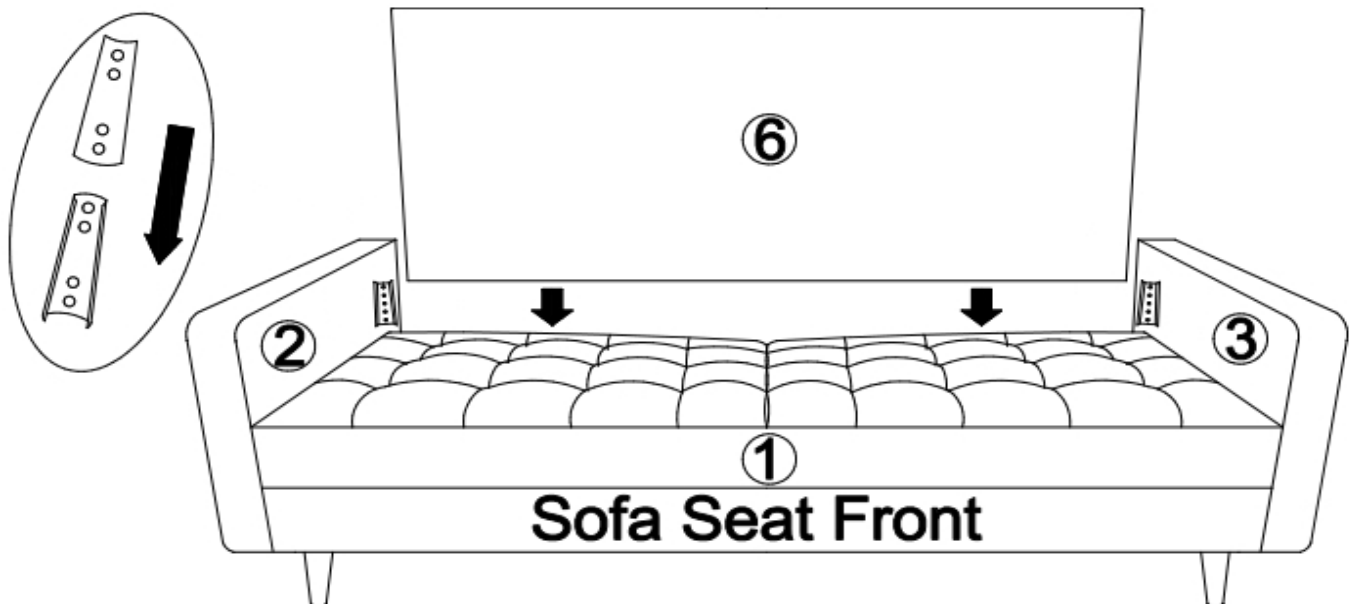

STEP 5:

1. Please put **Back Cushions Covers (9)** on a carpeted or padded area and fully open the zipper as shown. Insert 1 piece of **Back Cushions Core (7)** into **Back Cushion Cover (9)** until the Foam is fully embedded into the Cover and Zip up the Cover as shown.
2. Repeat the same steps for the remaining piece of **Back Cushions Core (7)** and **Back Cushion Cover(9)**.

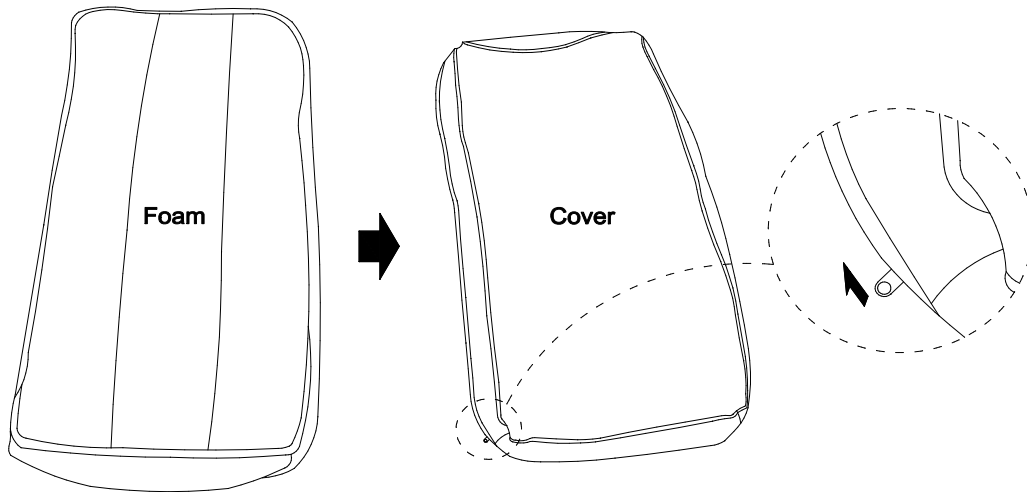

STEP 6:

Carefully put 2 pieces of **Back Cushions (7)** and 2 pieces of **Pillows (8)** to the assembled **Sofa Seat (1)**, **Left Arm (2)**, **Right Arm (3)** and **Sofa Back (6)** as shown.

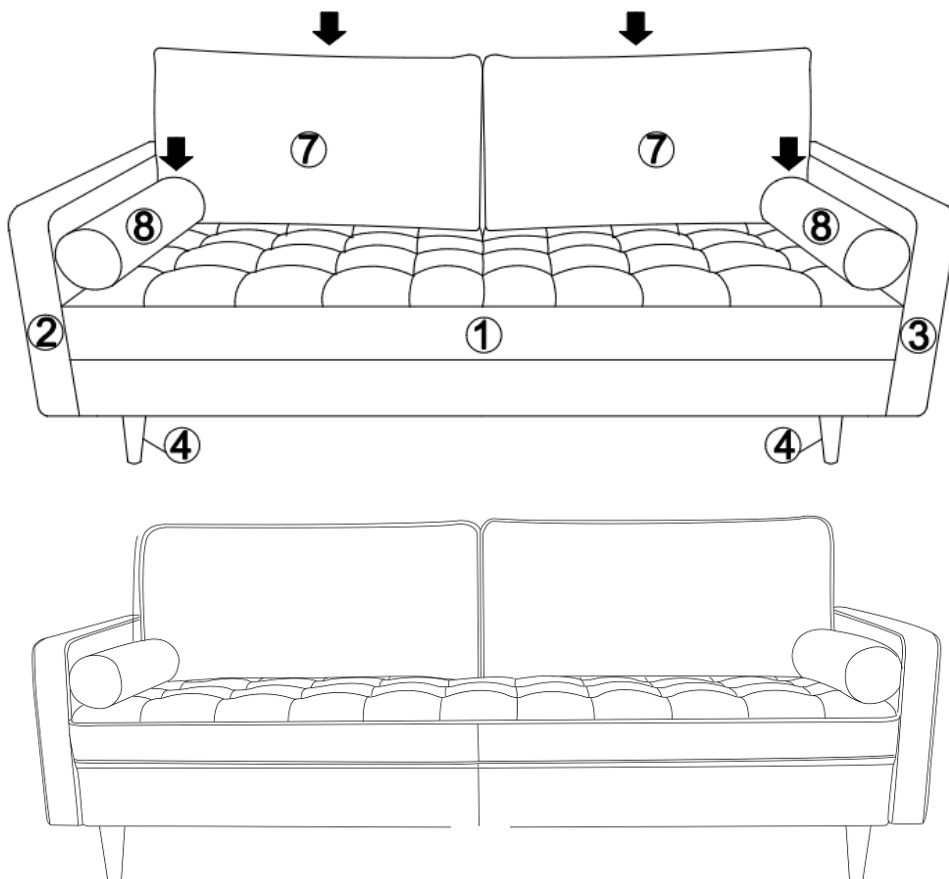

Assembly is complete. Your loveseat is ready to enjoy now !