

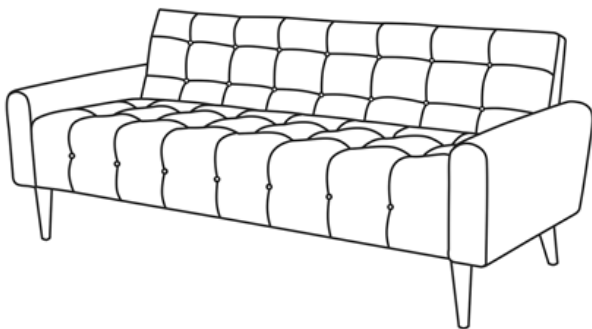



Thank you for purchasing the **MODWAY CHAIR/SOFA!**

Before you start, here is some helpful advice:

1. We suggest you spend a short time reading through this leaflet and then follow the simple step by step instructions.
2. Owing to the size and weight of the chair/sofa, we recommend that it is assembled by two adults, on a carpeted or padded area, in the room that it is intended for. Approximate assembly time: 30 minutes.
3. Please do not use any tools other than those provided or recommended in these instructions.
4. Please do not throw away any of the packaging or instructions until you have checked all the components and hardware and the furniture is fully assembled.
5. Assemble all components loosely until advised to tighten. Depending on use, it may be necessary to tighten the components from time to time, so please save the tools that have been provided.
6. Please keep all pieces out of reach of small children.



### Hardware:

A		Bolt M6x30mm	x 12
B		Spring Washer M6	x 12
C		Flat Washer M6	x 12
D		Allen Wrench	x 1

### Component:

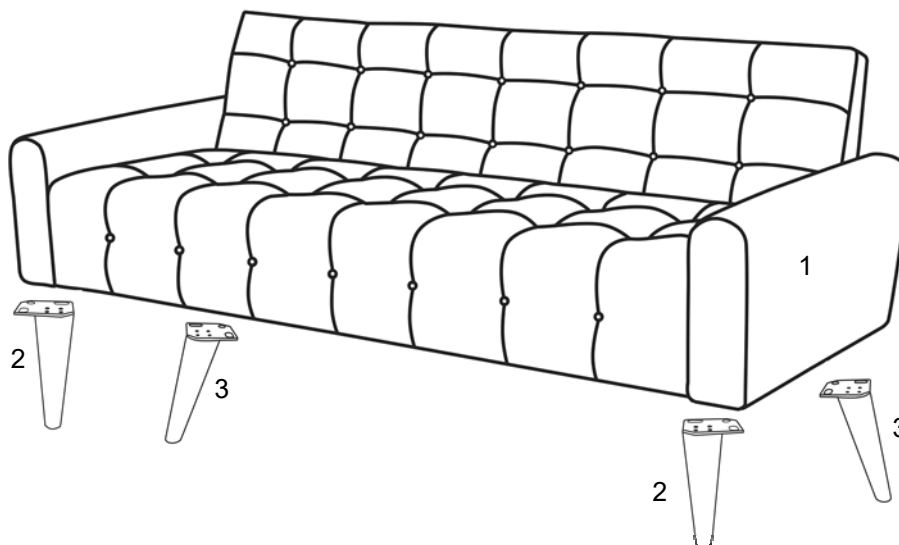

1 Chair/Sofa Body x1	2 Front Leg x2	3 Back Leg x2
----------------------	----------------	---------------

## STEP 1:

Please put the **Chair/Sofa Body (1)** upside down on a carpeted or padded area by two adults.  
 Open the Zipper on the bottom of **Chair/Sofa Body (1)** as shown, to make the corners fully visible.  
 Take out 4 pieces of **Leg (2&3)** and Hardware Package from the inside of **Chair/Sofa Body(1)**.

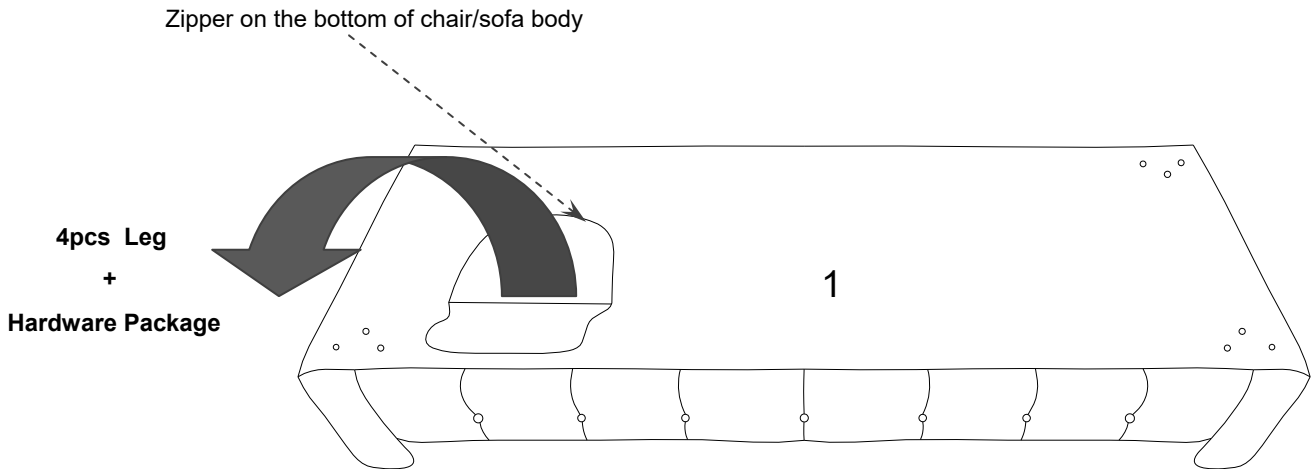

## STEP 2:

Position one of **Front Legs (2)** at the corresponding corner as shown.  
 Insert 3 pieces of **Bolt (A)** with 3 pieces of **Spring Washer (B)**, **Flat Washer (C)** into the pre-drilled holes on the bottom **Chair/Sofa Body (1)** through the pre-drill holes on **Front Leg (2)** as shown.  
 Repeat the same steps for the remaining **Front Leg (2)** and **Back Legs (3)**.  
 Use **Allen Wrench (D)** to tighten all the **Bolts (A)** clockwise until secure.  
 Close the zipper on bottom of **Chair/Sofa Body (1)**.

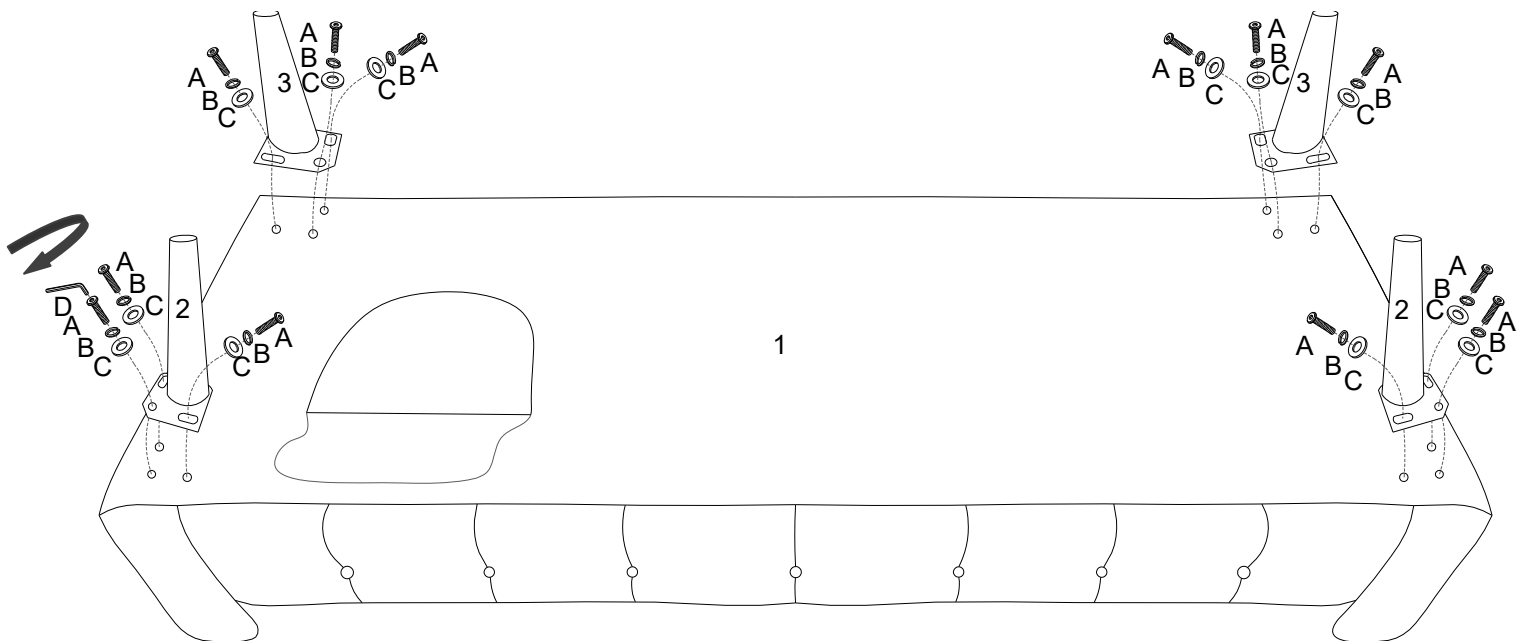

Ax12	Bx12	Cx12	Dx1

Hardware & Tool required

**STEP 3:**

Carefully turn over the assembled chair/sofa.

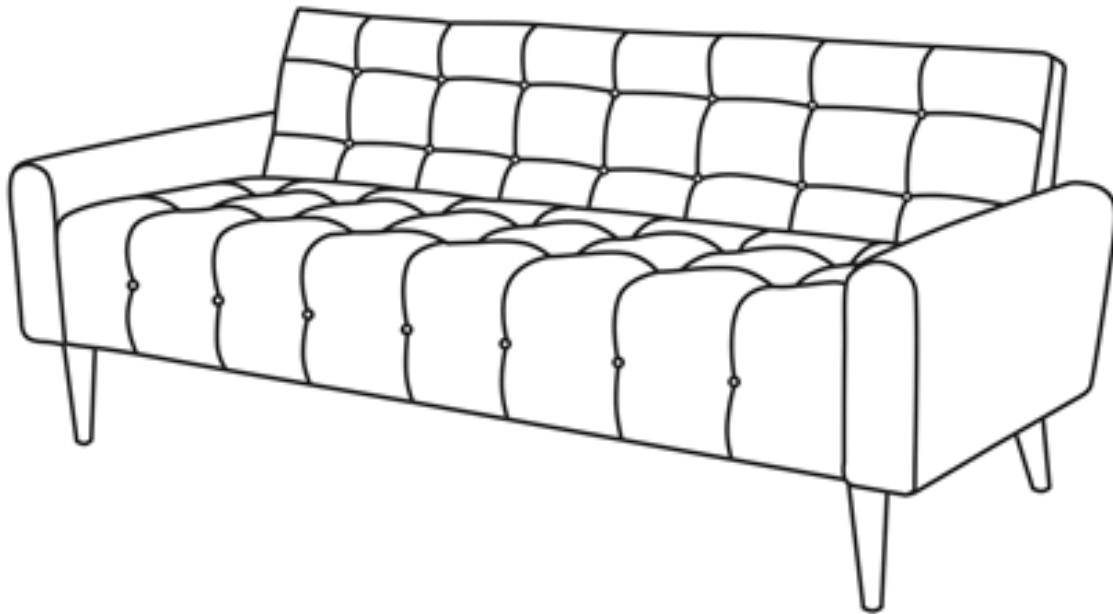

Assembly is completed. Your chair/sofa is ready to be enjoyed now!