

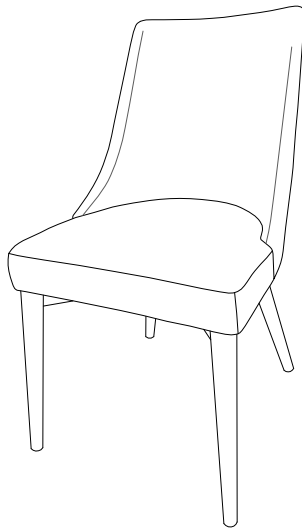



Thank you for purchasing the **MODWAY CHAIR!**

Before you start, here is some helpful advice:

1. We suggest you spend a short time reading through this leaflet and then follow the simple step by step instructions.
2. Owing to the size and weight of the chair, we recommend that it is assembled by two adults, on a carpeted or padded area, in the room that it is intended for. Approximate assembly time: 30 minutes.
3. Please do not use any tools other than those provided or recommended in these instructions.
4. Please do not throw away any of the packaging or instructions until you have checked all the components and hardware and the furniture is fully assembled.
5. Assemble all components loosely until advised to tighten. Depending on use, it may be necessary to tighten the components from time to time, so please save the tools that have been provided.
6. Please keep all pieces out of reach of small children.



### Hardware:

A		Bolt M6x45mm	x 4
B		Spring Washer M6	x 4
C		Flat Washer M6	x 4
D		Allen Wrench	x 1

### Component:

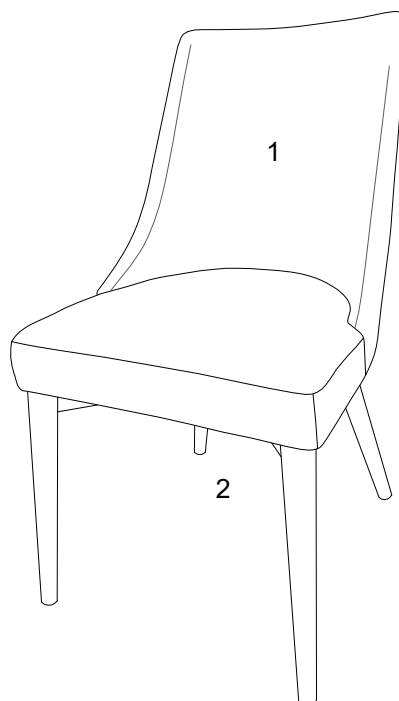

1 Chair Body x1

2 Bottom Base x1

## STEP 1:





Please put **Chair Body (1)** upside down on a carpeted or padded area.

Place **Bottom Base (2)** to bottom of the **Chair Body (1)** as shown.

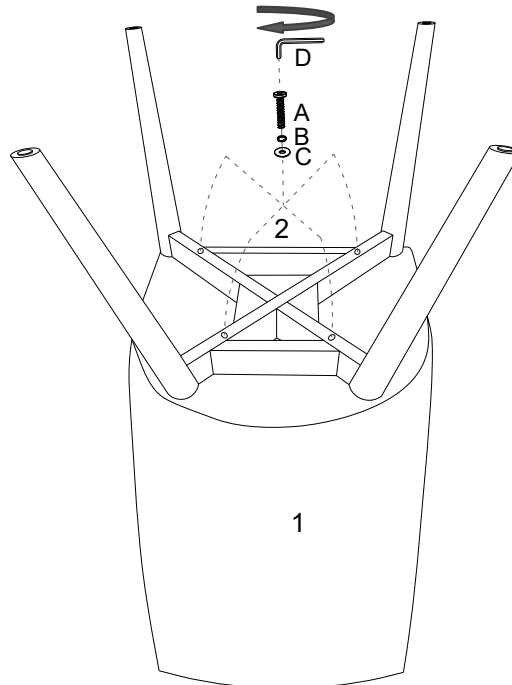
Attach by using 4 pieces of **Bolt (A)**, 4 pieces of **Spring Washer (B)** and 4 pieces of **Flat Washer (C)**.

Use **Allen Wrench (D)** to tighten all **Bolts (A)** clockwise until secure.



			
Ax4	Bx4	Cx4	Dx1

Hardware & Tool required

## STEP 2:

Carefully turn over the chair.

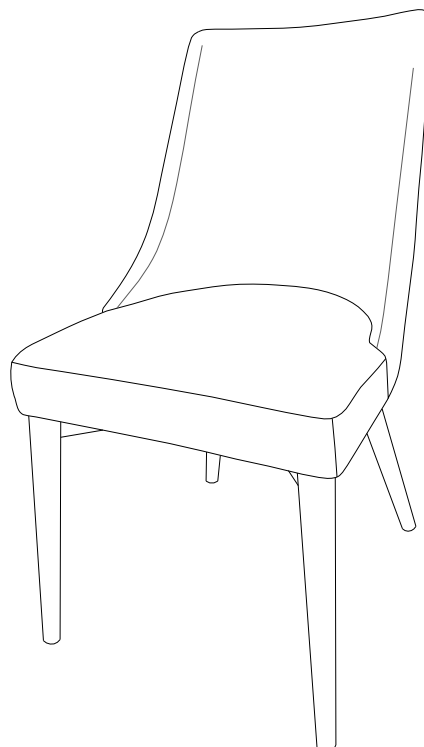

Assembly is completed. The chair is ready to use now!