

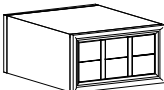





Assembly Instructions

ITEM NO: 36539

Thank you for purchasing this quality product. Be sure to check all packing material carefully for small parts that may have come loose inside the carton during shipment. (Note: Loosely thread all screws/bolts first. Once the item is assembled then completely tighten.)

PARTS LIST:				HARDWARE LIST:				
No.	Description	Sketch	Quality	No.	Sketch	Description	Size	Quality
1	Top Table		1 Pc	A		Allen Head Bolt	Ø8x20mm	12 Pcs
				B		Lock Washer	Ø8xØ13mm	12 Pcs
2	Metal Legs		4 Pcs	C		Flat Washer	Ø8xØ19mm	12 Pcs
				D		Allen Key	4x110mm	1 Pc

STEP 1

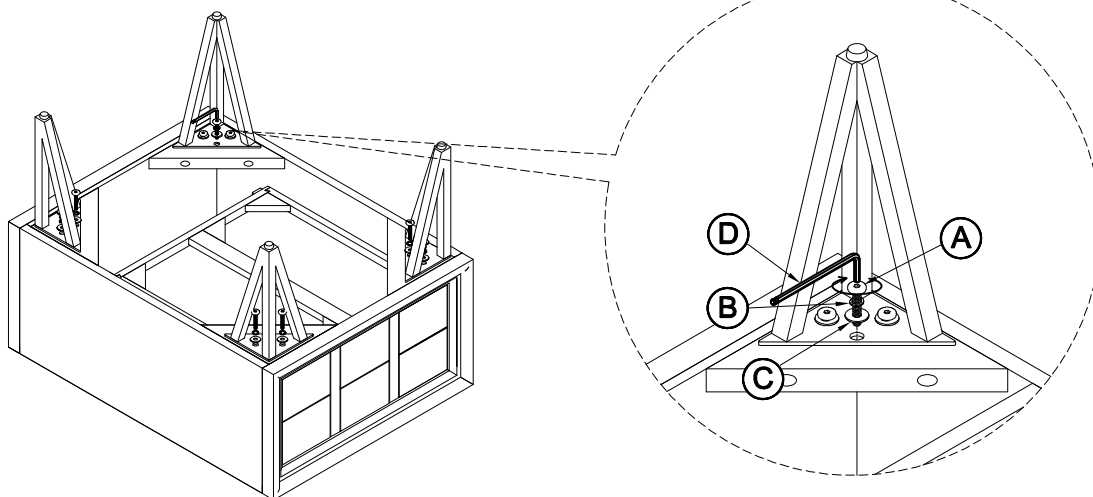

FINISH

