

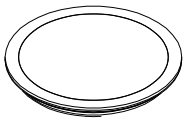





Thank you for purchasing this quality product. Be sure to check all packing material carefully for small parts that may have come loose inside the carton during shipment.(Note: Loosely thread all screws bolts first. Once the item is assembled then completely tighten.)

| PARTS LIST: | | | | HARDWARE LIST: | | | |
|-------------|--------------|---|-----|----------------|---|--|-----|
| NO. | DESCRIPTION | PART PHOTO | QTY | NO. | DESCRIPTION | PART PHOTO | QTY |
| A | TOP BOARD |  | 1 | E | ALLEN KEY ($\text{\O}^{\frac{4}{25}}\text{''}$) |  | 1 |
| | | | | F | SCREW ($M_{25}^{\frac{6}{5}}\text{''}\ast\frac{4}{5}\text{''}$) |  | 6 |
| B | BOTTOM BOARD |  | 1 | G | SCREW ($M_{25}^{\frac{6}{5}}\text{''}\ast 1\frac{1}{5}\text{''}$) |  | 3 |
| | | | | H | WASHER ($\text{\O}^{\frac{16}{25}}\text{''}-\text{\O}^{\frac{6}{25}}\text{''}\ast\frac{1}{25}\text{''}$) |  | 6 |
| C | SIDE FRAME |  | 2 | I | SPRING SHIM ($M_{25}^{\frac{6}{5}}\text{''}$) |  | 6 |
| | | | | | | | |
| D | SIDE FRAME |  | | | | | |
| | | | | | | | |

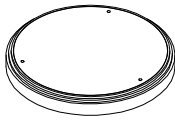
STEP 1

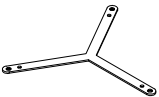

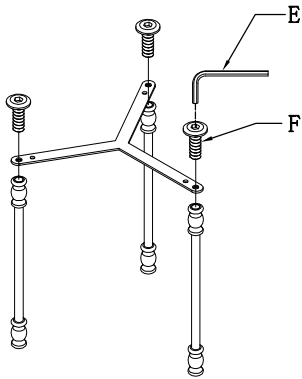
STEP 2

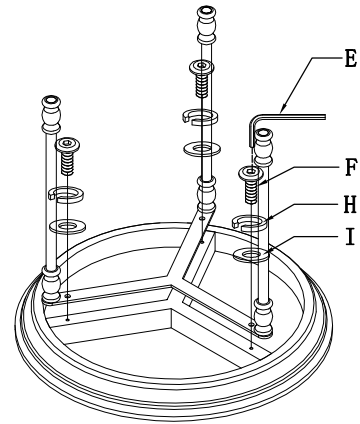

STEP 3

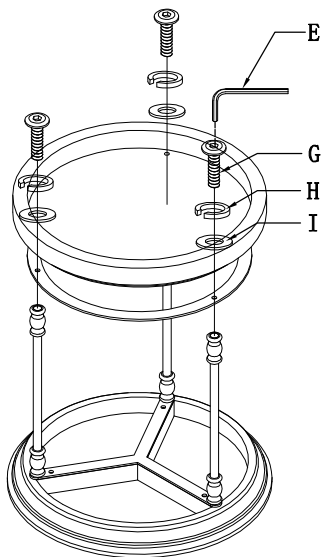

FINISH

